

OFFICINA MECCANICA



Utensili in Metallo Duro Integrale

DIVISIONE UTENSILI
SETTORE | STAMPI



DIVISIONE UTENSILI
SETTORE | STAMPI

Utensili in metallo duro per stampi, creati da chi gli stampi li costruisce.

L'evoluzione dei materiali, delle geometrie e delle macchine ci ha spinti a creare degli utensili specifici per questo tipo di mercato. Prodotti di qualità e totalmente personalizzati per venire in contro alle esigenze più specifiche.
I nostri prodotti possono essere creati ad hoc per ottenere il massimo.



OFFICINA MECCANICA

G.M. s.a.s.
dei **F.LLI MAFFEIS SIMONE E FEDERICO & C.**

COSTRUZIONI STAMPI
PER MATERIE PLASTICHE

Via Fantoni, 13
24049 **VERDELLO - BG - ITALY**

Tel. +39 035 4829554
Fax +39 035 48 29 667
e-mail divisioneutensili@gmmaffei.it



Legenda/

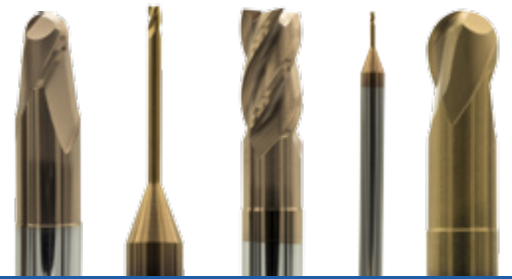

Legenda valori tabella

Ø1	Diametro del tagliente	U	Utile - Helpful (T+S)
Ø2	Diametro del gambo	L	Lunghezza totale utensile
<°	Sforno	E	Elica - Elix
R	Raggio (Esempio: Ø 4 R 2 = Fresa sferica da Ø 4)	Z	Numero Taglienti
T	Tagliente (Esempio: T1=Ø1 T2= Ø1x2 T1,3=Ø1x1,3)	HRC	Durezza materiale richiesta
S	Scarico Diametro scarico standard Ø1:40 Esempio: Ø ₁ =6 S=6-(6:40) = 5,85 S ₁ =Ø ₁ S ₂ =Ø ₁ x2 S 2,3 - Ø1x2,3		

Tipologia utensili tagliente

- CILINDRICO
- SFERICO
- TORICO
- GAMBO DRITTO
- GAMBO CONICO

Schema tecnico utensili

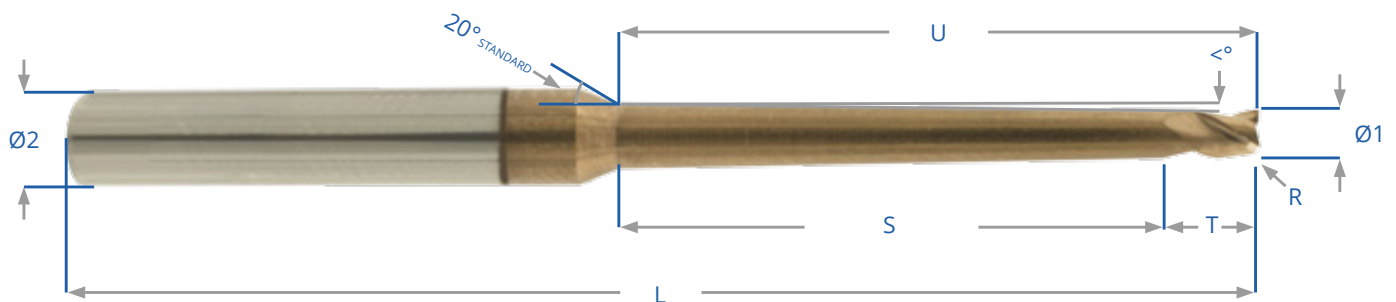

Caratteristiche tecniche utensili/

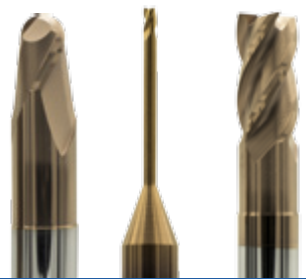

Materiale e Rivestimento / Coating

ACCIAIO

	AlTiN	TiAlN	TiSiN	Nano
Hardness (HV)	3200	2800	3600	42 (GF)
Thickness (µm)	2.5-3	2.5-3	3	3
Oxidation Temp (°C)	900	800	1000	1200
Friction Coefficient	0.3	0.3	0.45	0.4
HRC	45	50	55	65

Altri materiali

RAME : TiSiN

GRAFITE : Diamante

ALLUMINIO : Nessun rivestimento (NO Coating)

Parametri consigliati

DIAM.	FRESA SFERICA	FRESA TORICA	FRESA CILINDRICA
Ø0,5	S 19000	S19000	S19000
	F 300	F400	F400
	PP: 0,01/0,02	PP : 0,01/0,02	PP 0,01/0,02
Ø0,8	S18000	S18000	S18000
	F500	F 600	F 600
	PP 0,02/0,035	PP 0,02/0,035	PP 0,02/0,035
Ø1	S17000	S17000	S17000
	F600	F700	F800
	PP 0,02/0,05	PP 0,02/0,05	PP 0,02/0,05
Ø1,5	S 16500	S16500	S16500
	F800	F900	F1000
	PP 0,035/0,08	PP 0,035/0,08	PP 0,035/0,08
Ø2	S15000	S14000	S14000
	F1200	F1500	F1500
	PP 0,05/0,1	PP 0,05/0,1	PP 0,05-0,1
Ø3	S12500	S11000	S11000
	F1500/1800	F1600/2000	F 1600/2000
	0,05/0,12	PP 0,05/0,12	PP 0,05/0,12

DIAM.	FRESA SFERICA	FRESA TORICA	FRESA CILINDRICA
Ø4	S11000	S10500	S10000
	F2200/2500	F 2500/3000	F2500/3000
	PP 0,06/0,15	PP 0,06/0,15	PP 0,06/0,15
Ø6	S9500	S9000	S9000
	F2500/3000	F2500/3500	F2500/3500
	PP 0,07/0,018	PP 0,07/0,18	PP 0,07/0,18
Ø8	S 9000	S8500	S8000
	F2500/3500	F2500/4000	F 2500/3500
	PP 0,1/0,2	PP 0,1/0,2	PP 0,1/0,2
Ø10	S7500	S7500	S7000
	F2500/3500	F2500/4000	F 2500/3500
	PP 0,15/0,25	PP 0,15/0,25	PP 0,1/0,2
Ø12	S7500	S6500	S6000
	F 2500/3500	F2500/4000	F 2500/3500
	PP 0,15/0,25	PP 0,15/0,25	PP 0,15/0,2
Ø 16	S 6500	S6000	S6000
	F2500/3500	F 3000/5000	F 3000/4000
	PP 0,15/0,3	PP 0,15/0,3	PP 0,15/0,3

DIAMETRO > 0,5 <



Ø 0,5 CILINDRICHE A 2 DIAMETRI

PARAMETRI CONSIGLIATI

S	19000
F	400
PP	0,01/0,02

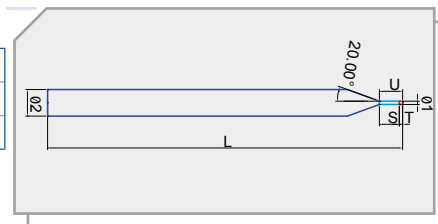

CODE: - Ø1-Ø2 - R - U-L - (T-S) - < - Z	DIAM.1	DIAM.2	0°-0,5°-1°-1,5°-2°...	RAGGIO	1XD-2XD-3XD SHARP	1XD-2XD-3XD Ø1/40	HELPFUL T+S	50/75 100/125	ELIX	FLUTES
	Ø 1	Ø 2	TAPER - (<°)	R	T	S	U	L	E 0°	Z
Ø0,5 - Ø4_6 - R0 - 2 - 50/75 - (T1-S3) - <0° - Z 2	0,5	4_6	0	0	1	3	2	50/75	30	2
Ø0,5 - Ø4_6 - R0 - 2,5 - 50/75 - (T1-S4) - <0° - Z 2	0,5	4_6	0	0	1	4	2,5	50/75	30	2
Ø0,5 - Ø4_6 - R0 - 3 - 50/75 - (T1-S5) - <0° - Z 2	0,5	4_6	0	0	1	5	3	50/75	30	2
Ø0,5 - Ø4_6 - R0 - 3,5 - 50/75 - (T1-S6) - <0° - Z 2	0,5	4_6	0	0	1	6	3,5	50/75	30	2
Ø0,5 - Ø4_6 - R0 - 4 - 50/75 - (T1-S7) - <0° - Z 2	0,5	4_6	0	0	1	7	4	50/75	30	2
Ø0,5 - Ø4_6 - R0 - 4,5 - 50/75 - (T1-S8) - <0° - Z 2	0,5	4_6	0	0	1	8	4,5	50/75	30	2
Ø0,5 - Ø4_6 - R0 - 5 - 50/75 - (T1-S9) - <0° - Z 2	0,5	4_6	0	0	1	9	5	50/75	30	2
Ø0,5 - Ø4_6 - R0 - 5,5 - 50/75 - (T1-S10) - <0° - Z 2	0,5	4_6	0	0	1	10	5,5	50/75	30	2
Ø0,5 - Ø4_6 - R0 - 6 - 50/75 - (T1-S11) - <0° - Z 2	0,5	4_6	0	0	1	11	6	50/75	30	2

TUTTI I NOSTRI UTENSILI SONO PERSONALIZZABILI IN OGNI PARAMENTRO

Vai a pagina 36 per scoprirne come chiedere i tuoi utensili personalizzati!



Ø 0,5 CILINDRICHE CONICHE

PARAMETRI CONSIGLIATI

S	19000
F	400
PP	0,01/0,02

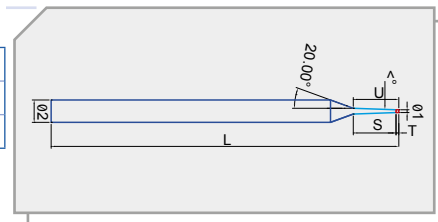

CODE: - Ø1-Ø2-R-U-L - (T-S) - < - Z	DIAM.1	DIAM.2	0°-0,5°-1°-1,5°-2°...	RAGGIO	1XD-2XD-3XD SHARP	1XD-2XD-3XD Ø1/40	HELPFUL T+S	50/75 100/125	ELIX	FLUTES
	Ø 1	Ø 2	TAPER - (<°)	R	T	S	U	L	E 0°	Z
Ø0,5-Ø4_6 - R0 - 2 - 50/75 - (T1-S3) - <0,5/1/1,5° - Z 2	0,5	4_6	0,5/1/1,5	0	1	3	2	50/75	30	2
Ø0,5 - Ø4_6 - R0 - 2,5 - 50/75 - (T1-S4) - <0,5/1/1,5° - Z 2	0,5	4_6	0,5/1/1,5	0	1	4	2,5	50/75	30	2
Ø0,5 - Ø4_6 - R0 - 3 - 50/75 - (T1-S5) - <0,5/1/1,5° - Z 2	0,5	4_6	0,5/1/1,5	0	1	5	3	50/75	30	2
Ø0,5 - Ø4_6 - R0 - 3,5 - 50/75 - (T1-S6) - <0,5/1/1,5° - Z 2	0,5	4_6	0,5/1/1,5	0	1	6	3,5	50/75	30	2
Ø0,5 - Ø4_6 - R0 - 4 - 50/75 - (T1-S7) - <0,5/1/1,5° - Z 2	0,5	4_6	0,5/1/1,5	0	1	7	4	50/75	30	2
Ø0,5 - Ø4_6 - R0 - 4,5 - 50/75 - (T1-S8) - <0,5/1/1,5° - Z 2	0,5	4_6	0,5/1/1,5	0	1	8	4,5	50/75	30	2
Ø0,5 - Ø4_6 - R0 - 5 - 50/75 - (T1-S9) - <0,5/1/1,5° - Z 2	0,5	4_6	0,5/1/1,5	0	1	9	5	50/75	30	2
Ø0,5 - Ø4_6 - R0 - 5,5 - 50/75 - (T1-S10) - <0,5/1/1,5° - Z 2	0,5	4_6	0,5/1/1,5	0	1	10	5,5	50/75	30	2
Ø0,5 - Ø4_6 - R0 - 6 - 50/75 - (T1-S11) - <0,5/1/1,5° - Z 2	0,5	4_6	0,5/1/1,5	0	1	11	6	50/75	30	2
Ø0,5 - Ø4_6 - R0 - 6,5 - 50/75 - (T1-S12) - <0,5/1/1,5° - Z 2	0,5	4_6	0,5/1/1,5	0	1	12	6,5	50/75	30	2
Ø0,5 - Ø4_6 - R0 - 7 - 50/75 - (T1-S13) - <0,5/1/1,5° - Z 2	0,5	4_6	0,5/1/1,5	0	1	13	7	50/75	30	2
Ø0,5 - Ø4_6 - R0 - 7,5 - 50/75 - (T1-S14) - <0,5/1/1,5° - Z 2	0,5	4_6	0,5/1/1,5	0	1	14	7,5	50/75	30	2

TUTTI I NOSTRI UTENSILI SONO PERSONALIZZABILI IN OGNI PARAMENTRO

Vai a pagina 36 per scoprirne come chiedere i tuoi utensili personalizzati!



PARAMETRI CONSIGLIATI

S	19000
F	300
PP	0,01/0,02

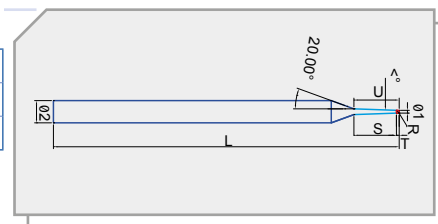

Ø 0,5 SFERICHE CONICHE

CODE: - Ø1-Ø2-R-U-L - (T-S) - < - Z	DIAM.1	DIAM.2	0°-0,5°-1°-1,5°-2°...	RAGGIO	1XD-2XD-3XD SHARP	1XD-2XD-3XD Ø1/40	HELPPFUL T+S	50/75 100/125	ELIX	FLUTES
	Ø 1	Ø 2	TAPER - (<°)	R	T	S	U	L	E 0°	Z
Ø0,5 - Ø4_6 - R0,25 - 2 - 50/75 - (T1-S3) - <0,5/1/1,5° - Z 2	0,5	4_6	0,5/1/1,5	0,25	1	3	2	50/75	30	2
Ø0,5 - Ø4_6 - R0,25 - 2,5 - 50/75 - (T1-S4) - <0,5/1/1,5° - Z 2	0,5	4_6	0,5/1/1,5	0,25	1	4	2,5	50/75	30	2
Ø0,5 - Ø4_6 - R0,25 - 3 - 50/75 - (T1-S5) - <0,5/1/1,5° - Z 2	0,5	4_6	0,5/1/1,5	0,25	1	5	3	50/75	30	2
Ø0,5 - Ø4_6 - R0,25 - 3,5 - 50/75 - (T1-S6) - <0,5/1/1,5° - Z 2	0,5	4_6	0,5/1/1,5	0,25	1	6	3,5	50/75	30	2
Ø0,5 - Ø4_6 - R0,25 - 4 - 50/75 - (T1-S7) - <0,5/1/1,5° - Z 2	0,5	4_6	0,5/1/1,5	0,25	1	7	4	50/75	30	2
Ø0,5 - Ø4_6 - R0,25 - 4,5 - 50/75 - (T1-S8) - <0,5/1/1,5° - Z 2	0,5	4_6	0,5/1/1,5	0,25	1	8	4,5	50/75	30	2
Ø0,5 - Ø4_6 - R0,25 - 5 - 50/75 - (T1-S9) - <0,5/1/1,5° - Z 2	0,5	4_6	0,5/1/1,5	0,25	1	9	5	50/75	30	2
Ø0,5 - Ø4_6 - R0,25 - 5,5 - 50/75 - (T1-S10) - <0,5/1/1,5° - Z	0,5	4_6	0,5/1/1,5	0,25	1	10	5,5	50/75	30	2
Ø0,5 - Ø4_6 - R0,25 - 6 - 50/75 - (T1-S11) - <0,5/1/1,5° - Z 2	0,5	4_6	0,5/1/1,5	0,25	1	11	6	50/75	30	2
Ø0,5 - Ø4_6 - R0,25 - 6,5 - 50/75 - (T1-S12) - <0,5/1/1,5° - Z 2	0,5	4_6	0,5/1/1,5	0,25	1	12	6,5	50/75	30	2
Ø0,5 - Ø4_6 - R0,25 - 7 - 50/75 - (T1-S13) - <0,5/1/1,5° - Z 2	0,5	4_6	0,5/1/1,5	0,25	1	13	7	50/75	30	2
Ø0,5 - Ø4_6 - R0,25 - 7,5 - 50/75 - (T1-S14) - <0,5/1/1,5° - Z 2	0,5	4_6	0,5/1/1,5	0,25	1	14	7,5	50/75	30	2

TUTTI I NOSTRI UTENSILI SONO PERSONALIZZABILI IN OGNI PARAMENTRO

Vai a pagina 36 per scoprirne come chiedere i tuoi utensili personalizzati!



PARAMETRI CONSIGLIATI

S	19000
F	300
PP	0,01/0,02

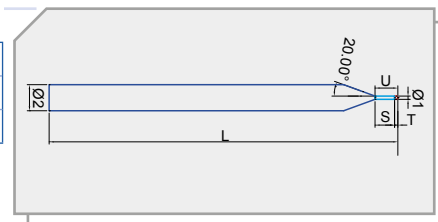

Ø 0,5 SFERICHE A 2 DIAMETRI

CODE: - Ø1-Ø2-R-U-L - (T-S) - < - Z	DIAM.1	DIAM.2	0°-0,5°-1°-1,5°-2°...	RAGGIO	1XD-2XD-3XD SHARP	1XD-2XD-3XD Ø1/40	HELPPFUL T+S	50/75 100/125	ELIX	FLUTES
	Ø 1	Ø 2	TAPER - (<°)	R	T	S	U	L	E 0°	Z
Ø0,5 - Ø4_6 - R0,25 - 2 - 50/75 - (T1-S3) - <0° - Z 2	0,5	4_6	0	0,25	1	3	2	50/75	30	2
Ø0,5 - Ø4_6 - R0,25 - 2,5 - 50/75 - (T1-S4) - <0° - Z 2	0,5	4_6	0	0,25	1	4	2,5	50/75	30	2
Ø0,5 - Ø4_6 - R0,25 - 3 - 50/75 - (T1-S5) - <0° - Z 2	0,5	4_6	0	0,25	1	5	3	50/75	30	2
Ø0,5 - Ø4_6 - R0,25 - 3,5 - 50/75 - (T1-S6) - <0° - Z 2	0,5	4_6	0	0,25	1	6	3,5	50/75	30	2
Ø0,5 - Ø4_6 - R0,25 - 4 - 50/75 - (T1-S7) - <0° - Z 2	0,5	4_6	0	0,25	1	7	4	50/75	30	2
Ø0,5 - Ø4_6 - R0,25 - 4,5 - 50/75 - (T1-S8) - <0° - Z 2	0,5	4_6	0	0,25	1	8	4,5	50/75	30	2
Ø0,5 - Ø4_6 - R0,25 - 5 - 50/75 - (T1-S9) - <0° - Z 2	0,5	4_6	0	0,25	1	9	5	50/75	30	2
Ø0,5 - Ø4_6 - R0,25 - 5,5 - 50/75 - (T1-S10) - <0° - Z 2	0,5	4_6	0	0,25	1	10	5,5	50/75	30	2
Ø0,5 - Ø4_6 - R0,25 - 6 - 50/75 - (T1-S11) - <0° - Z 2	0,5	4_6	0	0,25	1	11	6	50/75	30	2

TUTTI I NOSTRI UTENSILI SONO PERSONALIZZABILI IN OGNI PARAMENTRO

Vai a pagina 36 per scoprirne come chiedere i tuoi utensili personalizzati!

DIAMETRO > 0,8 <

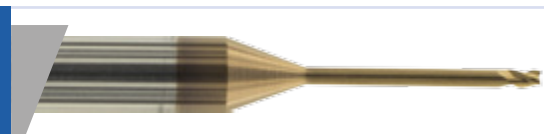

PARAMETRI CONSIGLIATI

S	1800
F	600
PP	0,02/0,035

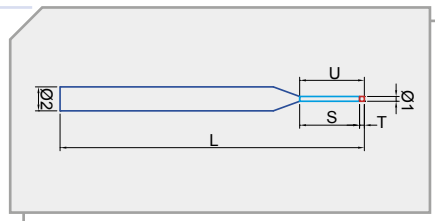

Ø 0,8 CILINDRICHE A 2 DIAMETRI

CODE: - Ø1-Ø2-R-U-L - (T-S) - < - z	DIAM.1	DIAM.2	0°-0,5°-1°-1,5°-2°...	RAGGIO	1XD-2XD-3XD SHARP	1XD-2XD-3XD Ø1/40	HELPPFUL T+S	50/75 100/125	ELIX	FLUTES
	Ø 1	Ø 2	TAPER - (<°)	R	T	S	U	L	E 0°	Z
Ø0,8 - Ø4,6 - R0 - 3,2 - 50/75 - (T1-S3) - <0° - Z 2	0,8	4,6	0	0	1	3	3,2	50/75	30	2,3
Ø0,8 - Ø4,6 - R0 - 4 - 50/75 - (T1-S4) - <0° - Z 2	0,8	4,6	0	0	1	4	4	50/75	30	2,3
Ø0,8 - Ø4,6 - R0 - 4,8 - 50/75 - (T1-S5) - <0° - Z 2	0,8	4,6	0	0	1	5	4,8	50/75	30	2,3
Ø0,8 - Ø4,6 - R0 - 5,6 - 50/75 - (T1-S6) - <0° - Z 2	0,8	4,6	0	0	1	6	5,6	50/75	30	2,3
Ø0,8 - Ø4,6 - R0 - 6,4 - 50/75 - (T1-S7) - <0° - Z 2	0,8	4,6	0	0	1	7	6,4	50/75	30	2,3
Ø0,8 - Ø4,6 - R0 - 7,2 - 50/75 - (T1-S8) - <0° - Z 2	0,8	4,6	0	0	1	8	7,2	50/75	30	2,3
Ø0,8 - Ø4,6 - R0 - 8 - 50/75 - (T1-S9) - <0° - Z 2	0,8	4,6	0	0	1	9	8	50/75	30	2,3
Ø0,8 - Ø4,6 - R0 - 8,8 - 50/75 - (T1-S10) - <0° - Z 2	0,8	4,6	0	0	1	10	8,8	50/75	30	2,3
Ø0,8 - Ø4,6 - R0 - 9,6 - 50/75 - (T1-S11) - <0° - Z 2	0,8	4,6	0	0	1	11	9,6	50/75	30	2,3
Ø0,8 - Ø4,6 - R0 - 10,4 - 50/75 - (T1-S12) - <0° - Z 2	0,8	4,6	0	0	1	12	10,4	50/75	30	2,3

TUTTI I NOSTRI UTENSILI SONO PERSONALIZZABILI IN OGNI PARAMENTRO

Vai a pagina 36 per scoprirne come chiedere i tuoi utensili personalizzati!



PARAMETRI CONSIGLIATI

S	1800
F	600
PP	0,02/0,035

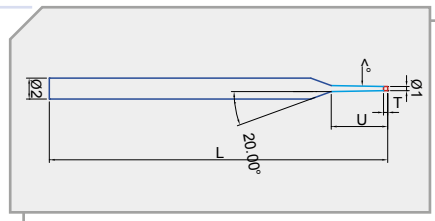

Ø 0,8 CILINDRICHE CONICHE

CODE: - Ø1-Ø2-R-U-L - (T-S) - < - z	DIAM.1	DIAM.2	0°-0,5°-1°-1,5°-2°...	RAGGIO	1XD-2XD-3XD SHARP	1XD-2XD-3XD Ø1/40	HELPPFUL T+S	50/75 100/125	ELIX	FLUTES
	Ø 1	Ø 2	TAPER - (<°)	R	T	S	U	L	E 0°	Z
Ø0,8 - Ø4,6 - R0 - 3,2 - 50/75 - (T1-S3) - <0,5/1/1,5° - Z 2	0,8	4,6	0,5/1/1,5	0	1	3	3,2	50/75	30	2,3
Ø0,8 - Ø4,6 - R0 - 4 - 50/75 - (T1-S4) - <0,5/1/1,5° - Z 2	0,8	4,6	0,5/1/1,5	0	1	4	4	50/75	30	2,3
Ø0,8 - Ø4,6 - R0 - 4,8 - 50/75 - (T1-S5) - <0,5/1/1,5° - Z 2	0,8	4,6	0,5/1/1,5	0	1	5	4,8	50/75	30	2,3
Ø0,8 - Ø4,6 - R0 - 5,6 - 50/75 - (T1-S6) - <0,5/1/1,5° - Z 2	0,8	4,6	0,5/1/1,5	0	1	6	5,6	50/75	30	2,3
Ø0,8 - Ø4,6 - R0 - 6,4 - 50/75 - (T1-S7) - <0,5/1/1,5° - Z 2	0,8	4,6	0,5/1/1,5	0	1	7	6,4	50/75	30	2,3
Ø0,8 - Ø4,6 - R0 - 7,2 - 50/75 - (T1-S8) - <0,5/1/1,5° - Z 2	0,8	4,6	0,5/1/1,5	0	1	8	7,2	50/75	30	2,3
Ø0,8 - Ø4,6 - R0 - 8 - 50/75 - (T1-S9) - <0,5/1/1,5° - Z 2	0,8	4,6	0,5/1/1,5	0	1	9	8	50/75	30	2,3
Ø0,8 - Ø4,6 - R0 - 8,8 - 50/75 - (T1-S10) - <0,5/1/1,5° - Z 2	0,8	4,6	0,5/1/1,5	0	1	10	8,8	50/75	30	
Ø0,8 - Ø4,6 - R0 - 9,6 - 50/75 - (T1-S11) - <0,5/1/1,5° - Z 2	0,8	4,6	0,5/1/1,5	0	1	11	9,6	50/75	30	2,3
Ø0,8 - Ø4,6 - R0 - 10,4 - 50/75 - (T1-S12) - <0,5/1/1,5° - Z 2	0,8	4,6	0,5/1/1,5	0	1	12	10,4	50/75	30	2,3
Ø0,8 - Ø4,6 - R0 - 11,2 - 50/75 - (T1-S13) - <0,5/1/1,5° - Z 2	0,8	4,6	0,5/1/1,5	0	1	13	11,2	50/75	30	2,3
Ø0,8 - Ø4,6 - R0 - 12 - 50/75 - (T1-S14) - <0,5/1/1,5° - Z 2	0,8	4,6	0,5/1/1,5	0	1	14	12	50/75	30	2,3

TUTTI I NOSTRI UTENSILI SONO PERSONALIZZABILI IN OGNI PARAMENTRO

Vai a pagina 36 per scoprirne come chiedere i tuoi utensili personalizzati!



SFERICHE A 2 DIAMETRI

PARAMETRI CONSIGLIATI

S	18000
F	500
PP	0,02/0,035

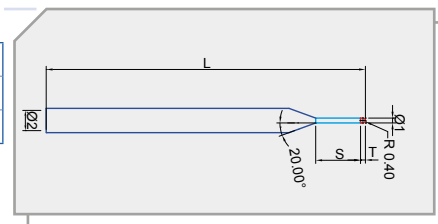

CODE: - Ø1-Ø2-R-U-L - (T-S) - < - z	DIAM.1	DIAM.2	0°-0,5°-1°-1,5°-2°...	RAGGIO	1XD-2XD-3XD SHARP	1XD-2XD-3XD Ø1/40	HELPFUL T+S	50/75 100/125	ELIX	FLUTES
	Ø 1	Ø 2	TAPER - (<°)	R	T	S	U	L	E 0°	Z
Ø0,8 - Ø4,6 - R0,4 - 3,2 - 50/75 - (T1-S3) - <0° - Z 2	0,8	4,6	0	0,4	1	3	3,2	50/75	30	2
Ø0,8 - Ø4,6 - R0,4 - 4 - 50/75 - (T1-S4) - <0° - Z 2	0,8	4,6	0	0,4	1	4	4	50/75	30	2
Ø0,8 - Ø4,6 - R0,4 - 4,8 - 50/75 - (T1-S5) - <0° - Z 2	0,8	4,6	0	0,4	1	5	4,8	50/75	30	2
Ø0,8 - Ø4,6 - R0,4 - 5,6 - 50/75 - (T1-S6) - <0° - Z 2	0,8	4,6	0	0,4	1	6	5,6	50/75	30	2
Ø0,8 - Ø4,6 - R0,4 - 6,4 - 50/75 - (T1-S7) - <0° - Z 2	0,8	4,6	0	0,4	1	7	6,4	50/75	30	2
Ø0,8 - Ø4,6 - R0,4 - 7,2 - 50/75 - (T1-S8) - <0° - Z 2	0,8	4,6	0	0,4	1	8	7,2	50/75	30	2
Ø0,8 - Ø4,6 - R0,4 - 8 - 50/75 - (T1-S9) - <0° - Z 2	0,8	4,6	0	0,4	1	9	8	50/75	30	2
Ø0,8 - Ø4,6 - R0,4 - 8,8 - 50/75 - (T1-S10) - <0° - Z 2	0,8	4,6	0	0,4	1	10	8,8	50/75	30	2
Ø0,8 - Ø4,6 - R0,4 - 9,6 - 50/75 - (T1-S11) - <0° - Z 2	0,8	4,6	0	0,4	1	11	9,6	50/75	30	2
Ø0,8 - Ø4,6 - R0,4 - 10,4 - 50/75 - (T1-S12) - <0° - Z 2	0,8	4,6	0	0,4	1	12	10,4	50/75	30	2

TUTTI I NOSTRI UTENSILI SONO PERSONALIZZABILI IN OGNI PARAMENTRO

Vai a pagina 36 per scoprire come chiedere i tuoi utensili personalizzati!



Ø 0,8 SFERICHE CONICHE

PARAMETRI CONSIGLIATI

S	18000
F	500
PP	0,02/0,035

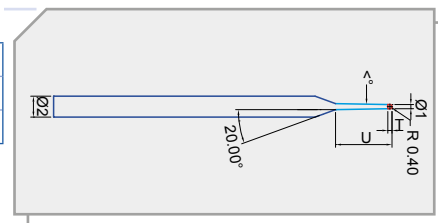

CODE: - Ø1-Ø2-R-U-L - (T-S) - < - z	DIAM.1	DIAM.2	0°-0,5°-1°-1,5°-2°...	RAGGIO	1XD-2XD-3XD SHARP	1XD-2XD-3XD Ø1/40	HELPFUL T+S	50/75 100/125	ELIX	FLUTES
	Ø 1	Ø 2	TAPER - (<°)	R	T	S	U	L	E 0°	Z
Ø0,8 - Ø4,6 - R0,4 - 3,2 - 50/75 - (T1-S3) - <0,5/1/1,5° - Z 2	0,8	4,6	0,5/1/1,5	0,4	1	3	3,2	50/75	30	2
Ø0,8 - Ø4,6 - R0,4 - 4 - 50/75 - (T1-S4) - <0,5/1/1,5° - Z 2	0,8	4,6	0,5/1/1,5	0,4	1	4	4	50/75	30	2
Ø0,8 - Ø4,6 - R0,4 - 4,8 - 50/75 - (T1-S5) - <0,5/1/1,5° - Z 2	0,8	4,6	0,5/1/1,5	0,4	1	5	4,8	50/75	30	2
Ø0,8 - Ø4,6 - R0,4 - 5,6 - 50/75 - (T1-S6) - <0,5/1/1,5° - Z 2	0,8	4,6	0,5/1/1,5	0,4	1	6	5,6	50/75	30	2
Ø0,8 - Ø4,6 - R0,4 - 6,4 - 50/75 - (T1-S7) - <0,5/1/1,5° - Z 2	0,8	4,6	0,5/1/1,5	0,4	1	7	6,4	50/75	30	2
Ø0,8 - Ø4,6 - R0,4 - 7,2 - 50/75 - (T1-S8) - <0,5/1/1,5° - Z 2	0,8	4,6	0,5/1/1,5	0,4	1	8	7,2	50/75	30	2
Ø0,8 - Ø4,6 - R0,4 - 8 - 50/75 - (T1-S9) - <0,5/1/1,5° - Z 2	0,8	4,6	0,5/1/1,5	0,4	1	9	8	50/75	30	2
Ø0,8 - Ø4,6 - R0,4 - 8,8 - 50/75 - (T1-S10) - <0,5/1/1,5° - Z 2	0,8	4,6	0,5/1/1,5	0,4	1	10	8,8	50/75	30	2
Ø0,8 - Ø4,6 - R0,4 - 9,6 - 50/75 - (T1-S11) - <0,5/1/1,5° - Z 2	0,8	4,6	0,5/1/1,5	0,4	1	11	9,6	50/75	30	2
Ø0,8 - Ø4,6 - R0,4 - 10,4 - 50/75 - (T1-S12) - <0,5/1/1,5° - Z 2	0,8	4,6	0,5/1/1,5	0,4	1	12	10,4	50/75	30	2
Ø0,8 - Ø4,6 - R0,4 - 11,2 - 50/75 - (T1-S13) - <0,5/1/1,5° - Z 2	0,8	4,6	0,5/1/1,5	0,4	1	13	11,2	50/75	30	2
Ø0,8 - Ø4,6 - R0,4 - 12 - 50/75 - (T1-S14) - <0,5/1/1,5° - Z 2	0,8	4,6	0,5/1/1,5	0,4	1	14	12	50/75	30	2

TUTTI I NOSTRI UTENSILI SONO PERSONALIZZABILI IN OGNI PARAMENTRO

Vai a pagina 36 per scoprire come chiedere i tuoi utensili personalizzati!



PARAMETRI CONSIGLIATI

S	18000
F	600
PP	0,02/0,035

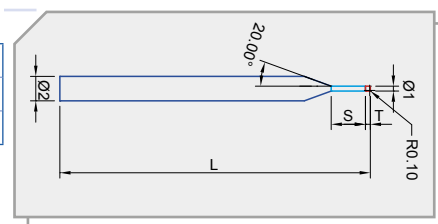

Ø 0,8 TORICHE A 2 DIAMETRI

CODE: - Ø1-Ø2-R-U-L - (T-S) - < - z	DIAM.1	DIAM.2	0°-0,5°-1°-1,5°-2°...	RAGGIO	1XD-2XD-3XD SHARP	1XD-2XD-3XD Ø1/40	HELPFUL T+S	50/75 100/125	ELIX	FLUTES
	Ø 1	Ø 2	TAPER - (<°)	R	T	S	U	L	E 0°	Z
Ø0,8 - Ø4,6 - R0,1/0,2 - 3,2 - 50/75 - (T1-S3) - <0° - Z	0,8	4,6	0	0,1/0,2	1	3	3,2	50/75	30	2,3
Ø0,8 - Ø4,6 - R0,1/0,2 - 4 - 50/75 - (T1-S4) - <0° - Z	0,8	4,6	0	0,1/0,2	1	4	4	50/75	30	2,3
Ø0,8 - Ø4,6 - R0,1/0,2 - 4,8 - 50/75 - (T1-S5) - <0° - Z	0,8	4,6	0	0,1/0,2	1	5	4,8	50/75	30	2,3
Ø0,8 - Ø4,6 - R0,1/0,2 - 5,6 - 50/75 - (T1-S6) - <0° - Z	0,8	4,6	0	0,1/0,2	1	6	5,6	50/75	30	2,3
Ø0,8 - Ø4,6 - R0,1/0,2 - 6,4 - 50/75 - (T1-S7) - <0° - Z	0,8	4,6	0	0,1/0,2	1	7	6,4	50/75	30	2,3
Ø0,8 - Ø4,6 - R0,1/0,2 - 7,2 - 50/75 - (T1-S8) - <0° - Z	0,8	4,6	0	0,1/0,2	1	8	7,2	50/75	30	2,3
Ø0,8 - Ø4,6 - R0,1/0,2 - 8 - 50/75 - (T1-S9) - <0° - Z	0,8	4,6	0	0,1/0,2	1	9	8	50/75	30	2,3
Ø0,8 - Ø4,6 - R0,1/0,2 - 8,8 - 50/75 - (T1-S10) - <0° - Z	0,8	4,6	0	0,1/0,2	1	10	8,8	50/75	30	2,3
Ø0,8 - Ø4,6 - R0,1/0,2 - 9,6 - 50/75 - (T1-S11) - <0° - Z	0,8	4,6	0	0,1/0,2	1	11	9,6	50/75	30	2,3
Ø0,8 - Ø4,6 - R0,1/0,2 - 10,4 - 50/75 - (T1-S12) - <0° - Z	0,8	4,6	0	0,1/0,2	1	12	10,4	50/75	30	2,3

TUTTI I NOSTRI UTENSILI SONO PERSONALIZZABILI IN OGNI PARAMENTRO

Vai a pagina 36 per scoprirne come chiedere i tuoi utensili personalizzati!



PARAMETRI CONSIGLIATI

S	18000
F	600
PP	0,02/0,035

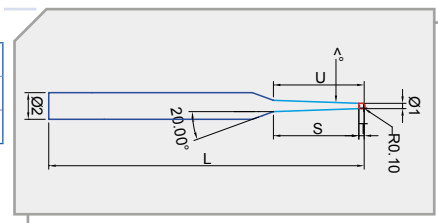

Ø 0,8 TORICHE CONICHE

CODE: - Ø1-Ø2-R-U-L - (T-S) - < - z	DIAM.1	DIAM.2	0°-0,5°-1°-1,5°-2°...	RAGGIO	1XD-2XD-3XD SHARP	1XD-2XD-3XD Ø1/40	HELPFUL T+S	50/75 100/125	ELIX	FLUTES
	Ø 1	Ø 2	TAPER - (<°)	R	T	S	U	L	E 0°	Z
Ø0,8 - Ø4,6 - R0,1/0,2 - 3,2 - 50/75 - (T1-S3) - <0,5/1/1,5° - Z 2	0,8	4,6	0,5/1/1,5	0,1/0,2	1	3	3,2	50/75	30	2,3
Ø0,8 - Ø4,6 - R0,1/0,2 - 4 - 50/75 - (T1-S4) - <0,5/1/1,5° - Z 2	0,8	4,6	0,5/1/1,5	0,1/0,2	1	4	4	50/75	30	2,3
Ø0,8 - Ø4,6 - R0,1/0,2 - 4,8 - 50/75 - (T1-S5) - <0,5/1/1,5° - Z 2	0,8	4,6	0,5/1/1,5	0,1/0,2	1	5	4,8	50/75	30	2,3
Ø0,8 - Ø4,6 - R0,1/0,2 - 5,6 - 50/75 - (T1-S6) - <0,5/1/1,5° - Z 2	0,8	4,6	0,5/1/1,5	0,1/0,2	1	6	5,6	50/75	30	2,3
Ø0,8 - Ø4,6 - R0,1/0,25 - 6,4 - 50/75 - (T1-S7) - <0,5/1/1,5° - Z 2	0,8	4,6	0,5/1/1,5	0,1/0,25	1	7	6,4	50/75	30	2,3
Ø0,8 - Ø4,6 - R0,1/0,2 - 7,2 - 50/75 - (T1-S8) - <0,5/1/1,5° - Z 2	0,8	4,6	0,5/1/1,5	0,1/0,2	1	8	7,2	50/75	30	2,3
Ø0,8 - Ø4,6 - R0,1/0,2 - 8 - 50/75 - (T1-S9) - <0,5/1/1,5° - Z 2	0,8	4,6	0,5/1/1,5	0,1/0,2	1	9	8	50/75	30	2,3
Ø0,8 - Ø4,6 - R0,1/0,2 - 8,8 - 50/75 - (T1-S10) - <0,5/1/1,5° - Z 2	0,8	4,6	0,5/1/1,5	0,1/0,2	1	10	8,8	50/75	30	2,3
Ø0,8 - Ø4,6 - R0,1/0,2 - 9,6 - 50/75 - (T1-S11) - <0,5/1/1,5° - Z 2	0,8	4,6	0,5/1/1,5	0,1/0,2	1	11	9,6	50/75	30	2,3
Ø0,8 - Ø4,6 - R0,1/0,2 - 10,4 - 50/75 - (T1-S12) - <0,5/1/1,5° - Z 2	0,8	4,6	0,5/1/1,5	0,1/0,2	1	12	10,4	50/75	30	2,3
Ø0,8 - Ø4,6 - R0,1/0,2 - 11,2 - 50/75 - (T1-S13) - <0,5/1/1,5° - Z 2	0,8	4,6	0,5/1/1,5	0,1/0,2	1	13	11,2	50/75	30	2,3
Ø0,8 - Ø4,6 - R0,1/0,2 - 12 - 50/75 - (T1-S14) - <0,5/1/1,5° - Z 2	0,8	4,6	0,5/1/1,5	0,1/0,2	1	14	12	50/75	30	2,3

TUTTI I NOSTRI UTENSILI SONO PERSONALIZZABILI IN OGNI PARAMENTRO

Vai a pagina 36 per scoprirne come chiedere i tuoi utensili personalizzati!

DIAMETRO > 1 <

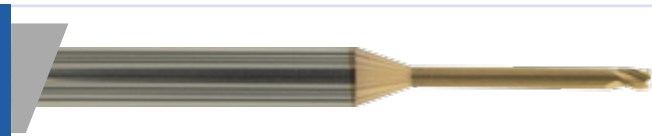

PARAMETRI CONSIGLIATI

S	17000
F	800
PP	0,02/0,05

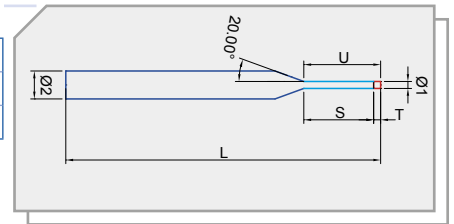

Ø1 CILINDRICHE A 2 DIAMETRI

CODE: - Ø1-Ø2-R-U-L - (T-S) - < - z	DIAM.1	DIAM.2	0°-0,5°-1°-1,5°-2°...	RAGGIO	1XD-2XD-3XD SHARP	1XD-2XD-3XD Ø1/40	HELPFUL T+S	50/75 100/125	ELIX	FLUTES
	Ø 1	Ø 2	TAPER - (<°)	R	T	S	U	L	E 0°	Z
Ø1 - Ø4_6 - R0 - 4 - 50/75 - (T1-S3) - <0° - Z 2_3	1	4_6	0	0	1	3	4	50/75	30	2_3
Ø1 - Ø4_6 - R0 - 5 - 50/75 - (T1-S4) - <0° - Z 2_3	1	4_6	0	0	1	4	5	50/75	30	2_3
Ø1 - Ø4_6 - R0 - 6 - 50/75 - (T1-S5) - <0° - Z 2_3	1	4_6	0	0	1	5	6	50/75	30	2_3
Ø1 - Ø4_6 - R0 - 7 - 50/75 - (T1-S6) - <0° - Z 2_3	1	4_6	0	0	1	6	7	50/75	30	2_3
Ø1 - Ø4_6 - R0 - 8 - 50/75 - (T1-S7) - <0° - Z 2_3	1	4_6	0	0	1	7	8	50/75	30	2_3
Ø1 - Ø4_6 - R0 - 9 - 50/75 - (T1-S8) - <0° - Z 2_3	1	4_6	0	0	1	8	9	50/75	30	2_3
Ø1 - Ø4_6 - R0 - 10 - 50/75 - (T1-S9) - <0° - Z 2_3	1	4_6	0	0	1	9	10	50/75	30	2_3
Ø1 - Ø4_6 - R0 - 11 - 50/75 - (T1-S10) - <0° - Z 2_3	1	4_6	0	0	1	10	11	50/75	30	2_3
Ø1 - Ø4_6 - R0 - 12 - 50/75 - (T1-S11) - <0° - Z 2_3	1	4_6	0	0	1	11	12	50/75	30	2_3
Ø1 - Ø4_6 - R0 - 13 - 50/75 - (T1-S12) - <0° - Z 2_3	1	4_6	0	0	1	12	13	50/75	30	2_3

TUTTI I NOSTRI UTENSILI SONO PERSONALIZZABILI IN OGNI PARAMENTRO

Vai a pagina 36 per scoprirne come chiedere i tuoi utensili personalizzati!



PARAMETRI CONSIGLIATI

S	17000
F	800
PP	0,02/0,05

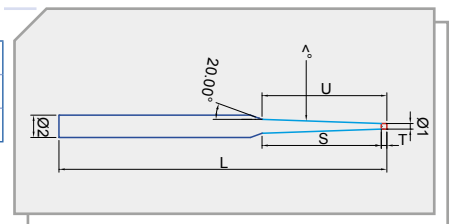

Ø1 CILINDRICHE CONICHE

CODE: - Ø1-Ø2-R-U-L - (T-S) - < - z	DIAM.1	DIAM.2	0°-0,5°-1°-1,5°-2°...	RAGGIO	1XD-2XD-3XD SHARP	1XD-2XD-3XD Ø1/40	HELPFUL T+S	50/75 100/125	ELIX	FLUTES
	Ø 1	Ø 2	TAPER - (<°)	R	T	S	U	L	E 0°	Z
Ø1 - Ø4_6 - R0 - 4 - 50/75 - (T1-S3) - <0,5/1/1,5° - Z 2_3	1	4_6	0,5/1/1,5	0	1	3	4	50/75	30	2_3
Ø1 - Ø4_6 - R0 - 5 - 50/75 - (T1-S4) - <0,5/1/1,5° - Z 2_3	1	4_6	0,5/1/1,5	0	1	4	5	50/75	30	2_3
Ø1 - Ø4_6 - R0 - 6 - 50/75 - (T1-S5) - <0,5/1/1,5° - Z 2_3	1	4_6	0,5/1/1,5	0	1	5	6	50/75	30	2_3
Ø1 - Ø4_6 - R0 - 7 - 50/75 - (T1-S6) - <0,5/1/1,5° - Z 2_3	1	4_6	0,5/1/1,5	0	1	6	7	50/75	30	2_3
Ø1 - Ø4_6 - R0 - 8 - 50/75 - (T1-S7) - <0,5/1/1,5° - Z 2_3	1	4_6	0,5/1/1,5	0	1	7	8	50/75	30	2_3
Ø1 - Ø4_6 - R0 - 9 - 50/75 - (T1-S8) - <0,5/1/1,5° - Z 2_3	1	4_6	0,5/1/1,5	0	1	8	9	50/75	30	2_3
Ø1 - Ø4_6 - R0 - 10 - 50/75 - (T1-S9) - <0,5/1/1,5° - Z 2_3	1	4_6	0,5/1/1,5	0	1	9	10	50/75	30	2_3
Ø1 - Ø4_6 - R0 - 11 - 50/75 - (T1-S10) - <0,5/1/1,5° - Z 2_3	1	4_6	0,5/1/1,5	0	1	10	11	50/75	30	2_3
Ø1 - Ø4_6 - R0 - 12 - 50/75 - (T1-S11) - <0,5/1/1,5° - Z 2_3	1	4_6	0,5/1/1,5	0	1	11	12	50/75	30	2_3
Ø1 - Ø4_6 - R0 - 13 - 50/75 - (T1-S12) - <0,5/1/1,5° - Z 2_3	1	4_6	0,5/1/1,5	0	1	12	13	50/75	30	2_3
Ø1 - Ø4_6 - R0 - 14 - 50/75 - (T1-S13) - <0,5/1/1,5° - Z 2_3	1	4_6	0,5/1/1,5	0	1	13	14	50/75	30	2_3
Ø1 - Ø4_6 - R0 - 15 - 50/75 - (T1-S14) - <0,5/1/1,5° - Z 2_3	1	4_6	0,5/1/1,5	0	1	14	15	50/75	30	2_3

TUTTI I NOSTRI UTENSILI SONO PERSONALIZZABILI IN OGNI PARAMENTRO

Vai a pagina 36 per scoprirne come chiedere i tuoi utensili personalizzati!



PARAMETRI CONSIGLIATI

S	17000
F	600
PP	0,02/0,05

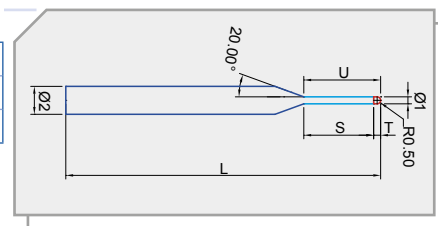

Ø1 SFERICHE A 2 DIAMETRI

CODE: - Ø1-Ø2-R-U-L - (T-S) - < - z	DIAM.1	DIAM.2	0°-0,5°-1°-1,5°-2°...	RAGGIO	1XD-2XD-3XD SHARP	1XD-2XD-3XD Ø1/40	HELPFUL T+S	50/75 100/125	ELIX	FLUTES
	Ø 1	Ø 2	TAPER - (<°)	R	T	S	U	L	E 0°	Z
Ø1 - Ø4_6 - R0,5 - 4 - 50/75 - (T1-S3) - <0° - Z 2	1	4_6	0	0,5	1	3	4	50/75	30	2
Ø1 - Ø4_6 - R0,5 - 5 - 50/75 - (T1-S4) - <0° - Z 2	1	4_6	0	0,5	1	4	5	50/75	30	2
Ø1 - Ø4_6 - R0,5 - 6 - 50/75 - (T1-S5) - <0° - Z 2	1	4_6	0	0,5	1	5	6	50/75	30	2
Ø1 - Ø4_6 - R0,5 - 7 - 50/75 - (T1-S6) - <0° - Z 2	1	4_6	0	0,5	1	6	7	50/75	30	2
Ø1 - Ø4_6 - R0,5 - 8 - 50/75 - (T1-S7) - <0° - Z 2	1	4_6	0	0,5	1	7	8	50/75	30	2
Ø1 - Ø4_6 - R0,5 - 9 - 50/75 - (T1-S8) - <0° - Z 2	1	4_6	0	0,5	1	8	9	50/75	30	2
Ø1 - Ø4_6 - R0,5 - 10 - 50/75 - (T1-S9) - <0° - Z 2	1	4_6	0	0,5	1	9	10	50/75	30	2
Ø1 - Ø4_6 - R0,5 - 11 - 50/75 - (T1-S10) - <0° - Z 2	1	4_6	0	0,5	1	10	11	50/75	30	2
Ø1 - Ø4_6 - R0,5 - 12 - 50/75 - (T1-S11) - <0° - Z 2	1	4_6	0	0,5	1	11	12	50/75	30	2
Ø1 - Ø4_6 - R0,5 - 13 - 50/75 - (T1-S12) - <0° - Z 2	1	4_6	0	0,5	1	12	13	50/75	30	2

TUTTI I NOSTRI UTENSILI SONO PERSONALIZZABILI IN OGNI PARAMENTRO

Vai a pagina 36 per scoprirne come chiedere i tuoi utensili personalizzati!



PARAMETRI CONSIGLIATI

S	17000
F	600
PP	0,02/0,05

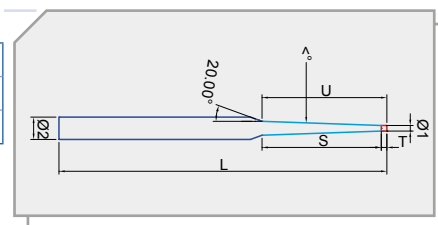

Ø1 SFERICHE CONICHE

CODE: - Ø1-Ø2-R-U-L - (T-S) - < - z	DIAM.1	DIAM.2	0°-0,5°-1°-1,5°-2°...	RAGGIO	1XD-2XD-3XD SHARP	1XD-2XD-3XD Ø1/40	HELPFUL T+S	50/75 100/125	ELIX	FLUTES
	Ø 1	Ø 2	TAPER - (<°)	R	T	S	U	L	E 0°	Z
Ø1 - Ø4_6 - R0,5 - 4 - 50/75 - (T1-S3) - <0,5/1/1,5° - Z 2	1	4_6	0,5/1/1,5	0,5	1	3	4	50/75	30	2
Ø1 - Ø4_6 - R0,5 - 5 - 50/75 - (T1-S4) - <0,5/1/1,5° - Z 2	1	4_6	0,5/1/1,5	0,5	1	4	5	50/75	30	2
Ø1 - Ø4_6 - R0,5 - 6 - 50/75 - (T1-S5) - <0,5/1/1,5° - Z 2	1	4_6	0,5/1/1,5	0,5	1	5	6	50/75	30	2
Ø1 - Ø4_6 - R0,5 - 7 - 50/75 - (T1-S6) - <0,5/1/1,5° - Z 2	1	4_6	0,5/1/1,5	0,5	1	6	7	50/75	30	2
Ø1 - Ø4_6 - R0,5 - 8 - 50/75 - (T1-S7) - <0,5/1/1,5° - Z 2	1	4_6	0,5/1/1,5	0,5	1	7	8	50/75	30	2
Ø1 - Ø4_6 - R0,5 - 9 - 50/75 - (T1-S8) - <0,5/1/1,5° - Z 2	1	4_6	0,5/1/1,5	0,5	1	8	9	50/75	30	2
Ø1 - Ø4_6 - R0,5 - 10 - 50/75 - (T1-S9) - <0,5/1/1,5° - Z 2	1	4_6	0,5/1/1,5	0,5	1	9	10	50/75	30	2
Ø1 - Ø4_6 - R0,5 - 11 - 50/75 - (T1-S10) - <0,5/1/1,5° - Z	1	4_6	0,5/1/1,5	0,5	1	10	11	50/75	30	2
Ø1 - Ø4_6 - R0,5 - 12 - 50/75 - (T1-S11) - <0,5/1/1,5° - Z 2	1	4_6	0,5/1/1,5	0,5	1	11	12	50/75	30	2
Ø1 - Ø4_6 - R0,5 - 13 - 50/75 - (T1-S12) - <0,5/1/1,5° - Z 2	1	4_6	0,5/1/1,5	0,5	1	12	13	50/75	30	2
Ø1 - Ø4_6 - R0,5 - 14 - 50/75 - (T1-S13) - <0,5/1/1,5° - Z 2	1	4_6	0,5/1/1,5	0,5	1	13	14	50/75	30	2
Ø1 - Ø4_6 - R0,5 - 15 - 50/75 - (T1-S14) - <0,5/1/1,5° - Z 2	1	4_6	0,5/1/1,5	0,5	1	14	15	50/75	30	2

TUTTI I NOSTRI UTENSILI SONO PERSONALIZZABILI IN OGNI PARAMENTRO

Vai a pagina 36 per scoprirne come chiedere i tuoi utensili personalizzati!

Ø1



PARAMETRI CONSIGLIATI

S	17000
F	700
PP	0,02/0,05

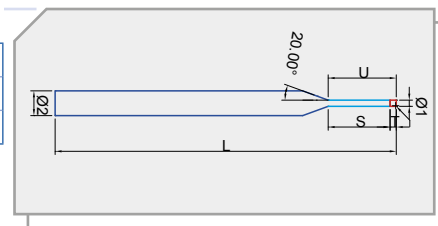

Ø1 TORICHE A 2 DIAMETRI

CODE: - Ø1-Ø2-R-U-L - (T-S) - < - z	DIAM.1	DIAM.2	0°-0.5°-1°-1.5°-2°...	RAGGIO	1XD-2XD-3XD SHARP	1XD-2XD-3XD Ø1/40	HELPFUL T+S	50/75 100/125	ELIX	FLUTES
	Ø 1	Ø 2	TAPER - (<°)	R	T	S	U	L	E 0°	Z
Ø1 - Ø4.6 - R0,1/0,2 - 4 - 50/75 - (T1-S3) - <0° - Z 2_3	1	4.6	0	0,1/0,2	1	3	4	50/75	30	2_3
Ø1 - Ø4.6 - R0,1/0,2 - 5 - 50/75 - (T1-S4) - <0° - Z 2_3	1	4.6	0	0,1/0,2	1	4	5	50/75	30	2_3
Ø1 - Ø4.6 - R0,1/0,2 - 6 - 50/75 - (T1-S5) - <0° - Z 2_3	1	4.6	0	0,1/0,2	1	5	6	50/75	30	2_3
Ø1 - Ø4.6 - R0,1/0,2 - 7 - 50/75 - (T1-S6) - <0° - Z 2_3	1	4.6	0	0,1/0,2	1	6	7	50/75	30	2_3
Ø1 - Ø4.6 - R0,1/0,2 - 8 - 50/75 - (T1-S7) - <0° - Z 2_3	1	4.6	0	0,1/0,2	1	7	8	50/75	30	2_3
Ø1 - Ø4.6 - R0,1/0,2 - 9 - 50/75 - (T1-S8) - <0° - Z 2_3	1	4.6	0	0,1/0,2	1	8	9	50/75	30	2_3
Ø1 - Ø4.6 - R0,1/0,2 - 10 - 50/75 - (T1-S9) - <0° - Z 2_3	1	4.6	0	0,1/0,2	1	9	10	50/75	30	2_3
Ø1 - Ø4.6 - R0,1/0,2 - 11 - 50/75 - (T1-S10) - <0° - Z 2_3	1	4.6	0	0,1/0,2	1	10	11	50/75	30	2_3
Ø1 - Ø4.6 - R0,1/0,2 - 12 - 50/75 - (T1-S11) - <0° - Z 2_3	1	4.6	0	0,1/0,2	1	11	12	50/75	30	2_3
Ø1 - Ø4.6 - R0,1/0,2 - 13 - 50/75 - (T1-S12) - <0° - Z 2_3	1	4.6	0	0,1/0,2	1	12	13	50/75	30	2_3

TUTTI I NOSTRI UTENSILI SONO PERSONALIZZABILI IN OGNI PARAMENTRO

Vai a pagina 36 per scoprire come chiedere i tuoi utensili personalizzati!



PARAMETRI CONSIGLIATI

S	17000
F	700
PP	0,02/0,05

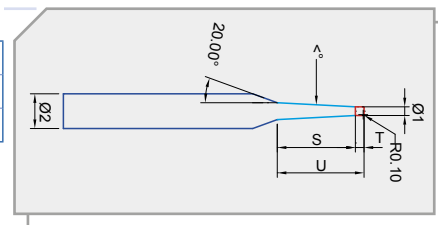

Ø1 TORICHE CONICHE

CODE: - Ø1-Ø2-R-U-L - (T-S) - < - z	DIAM.1	DIAM.2	0°-0.5°-1°-1.5°-2°...	RAGGIO	1XD-2XD-3XD SHARP	1XD-2XD-3XD Ø1/40	HELPFUL T+S	50/75 100/125	ELIX	FLUTES
	Ø 1	Ø 2	TAPER - (<°)	R	T	S	U	L	E 0°	Z
Ø1 - Ø4.6 - R0,1/0,2 - 4 - 50/75 - (T1-S3) - <0,5/1/1,5° - Z 2_3	1	4.6	0,5/1/1,5	0,1/0,2	1	3	4	50/75	30	2_3
Ø1 - Ø4.6 - R0,1/0,2 - 5 - 50/75 - (T1-S4) - <0,5/1/1,5° - Z 2_3	1	4.6	0,5/1/1,5	0,1/0,2	1	4	5	50/75	30	2_3
Ø1 - Ø4.6 - R0,1/0,2 - 6 - 50/75 - (T1-S5) - <0,5/1/1,5° - Z 2_3	1	4.6	0,5/1/1,5	0,1/0,2	1	5	6	50/75	30	2_3
Ø1 - Ø4.6 - R0,1/0,2 - 7 - 50/75 - (T1-S6) - <0,5/1/1,5° - Z 2_3	1	4.6	0,5/1/1,5	0,1/0,2	1	6	7	50/75	30	2_3
Ø1 - Ø4.6 - R0,1/0,25 - 8 - 50/75 - (T1-S7) - <0,5/1/1,5° - Z 2_3	1	4.6	0,5/1/1,5	0,1/0,25	1	7	8	50/75	30	2_3
Ø1 - Ø4.6 - R0,1/0,2 - 9 - 50/75 - (T1-S8) - <0,5/1/1,5° - Z 2_3	1	4.6	0,5/1/1,5	0,1/0,2	1	8	9	50/75	30	2_3
Ø1 - Ø4.6 - R0,1/0,2 - 10 - 50/75 - (T1-S9) - <0,5/1/1,5° - Z 2_3	1	4.6	0,5/1/1,5	0,1/0,2	1	9	10	50/75	30	2_3
Ø1 - Ø4.6 - R0,1/0,2 - 11 - 50/75 - (T1-S10) - <0,5/1/1,5° - Z 2_3	1	4.6	0,5/1/1,5	0,1/0,2	1	10	11	50/75	30	2_3
Ø1 - Ø4.6 - R0,1/0,2 - 12 - 50/75 - (T1-S11) - <0,5/1/1,5° - Z 2_3	1	4.6	0,5/1/1,5	0,1/0,2	1	11	12	50/75	30	2_3
Ø1 - Ø4.6 - R0,1/0,2 - 13 - 50/75 - (T1-S12) - <0,5/1/1,5° - Z 2_3	1	4.6	0,5/1/1,5	0,1/0,2	1	12	13	50/75	30	2_3
Ø1 - Ø4.6 - R0,1/0,2 - 14 - 50/75 - (T1-S13) - <0,5/1/1,5° - Z 2_3	1	4.6	0,5/1/1,5	0,1/0,2	1	13	14	50/75	30	2_3
Ø1 - Ø4.6 - R0,1/0,2 - 15 - 50/75 - (T1-S14) - <0,5/1/1,5° - Z 2_3	1	4.6	0,5/1/1,5	0,1/0,2	1	14	15	50/75	30	2_3

TUTTI I NOSTRI UTENSILI SONO PERSONALIZZABILI IN OGNI PARAMENTRO

Vai a pagina 36 per scoprire come chiedere i tuoi utensili personalizzati!



DIAMETRO > 1,5 <



PARAMETRI CONSIGLIATI

S	16500
F	1000
PP	0,035/0,08

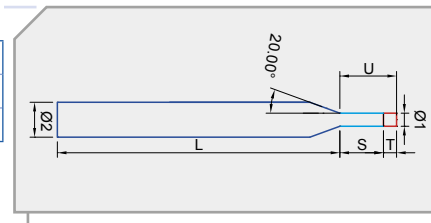

Ø1.5 CILINDRICHE A 2 DIAMETRI

CODE: - Ø1-Ø2-R-U-L - (T-S) - < - z	DIAM.1	DIAM.2	0°-0,5°-1°-1,5°-2°...	RAGGIO	1XD-2XD-3XD SHARP	1XD-2XD-3XD Ø1/40	HELPFUL T+S	50/75 100/125	ELIX	FLUTES
	Ø 1	Ø 2	TAPER - (<°)	R	T	S	U	L	E 0°	Z
Ø1,5 - Ø4_6 - R0 - 6 - 50/75 - (T1-S3) - <0° - Z 2_3	1,5	4_6	0	0	1	3	6	50/75	30	2_3
Ø1,5 - Ø4_6 - R0 - 7,5 - 50/75 - (T1-S4) - <0° - Z 2_3	1,5	4_6	0	0	1	4	7,5	50/75	30	2_3
Ø1,5 - Ø4_6 - R0 - 9 - 50/75 - (T1-S5) - <0° - Z 2_3	1,5	4_6	0	0	1	5	9	50/75	30	2_3
Ø1,5 - Ø4_6 - R0 - 10,5 - 50/75 - (T1-S6) - <0° - Z 2_3	1,5	4_6	0	0	1	6	10,5	50/75	30	2_3
Ø1,5 - Ø4_6 - R0 - 12 - 50/75 - (T1-S7) - <0° - Z 2_3	1,5	4_6	0	0	1	7	12	50/75	30	2_3
Ø1,5 - Ø4_6 - R0 - 13,5 - 50/75 - (T1-S8) - <0° - Z 2_3	1,5	4_6	0	0	1	8	13,5	50/75	30	2_3
Ø1,5 - Ø4_6 - R0 - 15 - 50/75 - (T1-S9) - <0° - Z 2_3	1,5	4_6	0	0	1	9	15	50/75	30	2_3
Ø1,5 - Ø4_6 - R0 - 16,5 - 50/75 - (T1-S10) - <0° - Z 2_3	1,5	4_6	0	0	1	10	16,5	50/75	30	2_3
Ø1,5 - Ø4_6 - R0 - 18 - 50/75 - (T1-S11) - <0° - Z 2_3	1,5	4_6	0	0	1	11	18	50/75	30	2_3
Ø1,5 - Ø4_6 - R0 - 19,5 - 50/75 - (T1-S12) - <0° - Z 2_3	1,5	4_6	0	0	1	12	19,5	50/75	30	2_3

TUTTI I NOSTRI UTENSILI SONO PERSONALIZZABILI IN OGNI PARAMENTRO

Vai a pagina 36 per scoprirne come chiedere i tuoi utensili personalizzati!



PARAMETRI CONSIGLIATI

S	16500
F	1000
PP	0,035/0,08

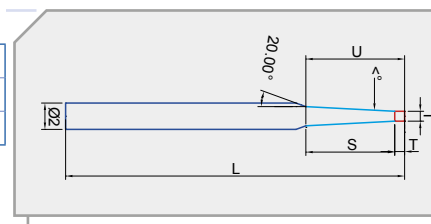

Ø1,5 CILINDRICHE CONICHE

CODE: - Ø1-Ø2-R-U-L - (T-S) - < - z	DIAM.1	DIAM.2	0°-0,5°-1°-1,5°-2°...	RAGGIO	1XD-2XD-3XD SHARP	1XD-2XD-3XD Ø1/40	HELPFUL T+S	50/75 100/125	ELIX	FLUTES
	Ø 1	Ø 2	TAPER - (<°)	R	T	S	U	L	E 0°	Z
Ø1,5 - Ø4_6 - R0 - 6 - 50/75 - (T1-S3) - <0,5/1/1,5° - Z 2_3	1,5	4_6	0,5/1/1,5	0	1	3	6	50/75	30	2_3
Ø1,5 - Ø4_6 - R0 - 7,5 - 50/75 - (T1-S4) - <0,5/1/1,5° - Z 2_3	1,5	4_6	0,5/1/1,5	0	1	4	7,5	50/75	30	2_3
Ø1,5 - Ø4_6 - R0 - 9 - 50/75 - (T1-S5) - <0,5/1/1,5° - Z 2_3	1,5	4_6	0,5/1/1,5	0	1	5	9	50/75	30	2_3
Ø1,5 - Ø4_6 - R0 - 10,5 - 50/75 - (T1-S6) - <0,5/1/1,5° - Z 2_3	1,5	4_6	0,5/1/1,5	0	1	6	10,5	50/75	30	2_3
Ø1,5 - Ø4_6 - R0 - 12 - 50/75 - (T1-S7) - <0,5/1/1,5° - Z 2_3	1,5	4_6	0,5/1/1,5	0	1	7	12	50/75	30	2_3
Ø1,5 - Ø4_6 - R0 - 13,5 - 50/75 - (T1-S8) - <0,5/1/1,5° - Z 2_3	1,5	4_6	0,5/1/1,5	0	1	8	13,5	50/75	30	2_3
Ø1,5 - Ø4_6 - R0 - 15 - 50/75 - (T1-S9) - <0,5/1/1,5° - Z 2_3	1,5	4_6	0,5/1/1,5	0	1	9	15	50/75	30	2_3
Ø1,5 - Ø4_6 - R0 - 16,5 - 50/75 - (T1-S10) - <0,5/1/1,5° - Z 2_3	1,5	4_6	0,5/1/1,5	0	1	10	16,5	50/75	30	2_3
Ø1,5 - Ø4_6 - R0 - 18 - 50/75 - (T1-S11) - <0,5/1/1,5° - Z 2_3	1,5	4_6	0,5/1/1,5	0	1	11	18	50/75	30	2_3
Ø1,5 - Ø4_6 - R0 - 19,5 - 50/75 - (T1-S12) - <0,5/1/1,5° - Z 2_3	1,5	4_6	0,5/1/1,5	0	1	12	19,5	50/75	30	2_3

TUTTI I NOSTRI UTENSILI SONO PERSONALIZZABILI IN OGNI PARAMENTRO

Vai a pagina 36 per scoprirne come chiedere i tuoi utensili personalizzati!



PARAMETRI CONSIGLIATI

S	16500
F	800
PP	0,035/0,08

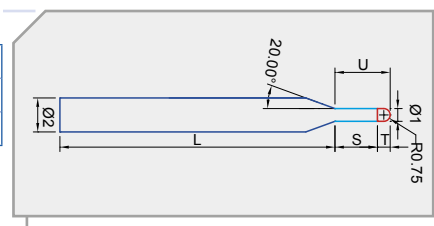

Ø1,5 SFERICHE A 2 DIAMETRI

CODE: - Ø1-Ø2-R-U-L - (T-S) - < - z	DIAM.1	DIAM.2	0°-0,5°-1°-1,5°-2°...	RAGGIO	1XD-2XD-3XD SHARP	1XD-2XD-3XD Ø1/40	HELFPFUL T+S	50/75 100/125	ELIX	FLUTES
	Ø 1	Ø 2	TAPER - (<°)	R	T	S	U	L	E 0°	Z
Ø1,5 - Ø4_6 - R0,75 - 6 - 50/75 - (T1-S3) - <0° - Z 2	1,5	4_6	0	0,75	1	3	6	50/75	30	2
Ø1,5 - Ø4_6 - R0,75 - 7,5 - 50/75 - (T1-S4) - <0° - Z 2	1,5	4_6	0	0,75	1	4	7,5	50/75	30	2
Ø1,5 - Ø4_6 - R0,75 - 9 - 50/75 - (T1-S5) - <0° - Z 2	1,5	4_6	0	0,75	1	5	9	50/75	30	2
Ø1,5 - Ø4_6 - R0,75 - 10,5 - 50/75 - (T1-S6) - <0° - Z 2	1,5	4_6	0	0,75	1	6	10,5	50/75	30	2
Ø1,5 - Ø4_6 - R0,75 - 12 - 50/75 - (T1-S7) - <0° - Z 2	1,5	4_6	0	0,75	1	7	12	50/75	30	2
Ø1,5 - Ø4_6 - R0,75 - 13,5 - 50/75 - (T1-S8) - <0° - Z 2	1,5	4_6	0	0,75	1	8	13,5	50/75	30	2
Ø1,5 - Ø4_6 - R0,75 - 15 - 50/75 - (T1-S9) - <0° - Z 2	1,5	4_6	0	0,75	1	9	15	50/75	30	2
Ø1,5 - Ø4_6 - R0,75 - 16,5 - 50/75 - (T1-S10) - <0° - Z 2	1,5	4_6	0	0,75	1	10	16,5	50/75	30	2
Ø1,5 - Ø4_6 - R0,75 - 18 - 50/75 - (T1-S11) - <0° - Z 2	1,5	4_6	0	0,75	1	11	18	50/75	30	2
Ø1,5 - Ø4_6 - R0,75 - 19,5 - 50/75 - (T1-S12) - <0° - Z 2	1,5	4_6	0	0,75	1	12	19,5	50/75	30	2

TUTTI I NOSTRI UTENSILI SONO PERSONALIZZABILI IN OGNI PARAMENTRO

Vai a pagina 36 per scoprirne come chiedere i tuoi utensili personalizzati!



PARAMETRI CONSIGLIATI

S	16500
F	800
PP	0,035/0,08

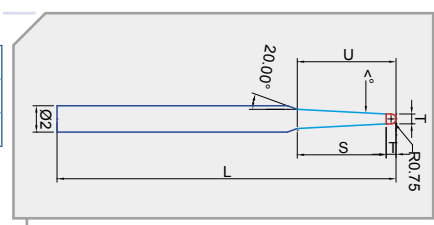

Ø1,5 SFERICHE CONICHE

CODE: - Ø1-Ø2-R-U-L - (T-S) - < - z	DIAM.1	DIAM.2	0°-0,5°-1°-1,5°-2°...	RAGGIO	1XD-2XD-3XD SHARP	1XD-2XD-3XD Ø1/40	HELFPFUL T+S	50/75 100/125	ELIX	FLUTES
	Ø 1	Ø 2	TAPER - (<°)	R	T	S	U	L	E 0°	Z
Ø1,5 - Ø4_6 - R0,75 - 6 - 50/75 - (T1-S3) - <0,5/1/1,5° - Z 2	1,5	4_6	0,5/1/1,5	0,75	1	3	6	50/75	30	2
Ø1,5 - Ø4_6 - R0,75 - 7,5 - 50/75 - (T1-S4) - <0,5/1/1,5° - Z 2	1,5	4_6	0,5/1/1,5	0,75	1	4	7,5	50/75	30	2
Ø1,5 - Ø4_6 - R0,75 - 9 - 50/75 - (T1-S5) - <0,5/1/1,5° - Z 2	1,5	4_6	0,5/1/1,5	0,75	1	5	9	50/75	30	2
Ø1,5 - Ø4_6 - R0,75 - 10,5 - 50/75 - (T1-S6) - <0,5/1/1,5° - Z 2	1,5	4_6	0,5/1/1,5	0,75	1	6	10,5	50/75	30	2
Ø1,5 - Ø4_6 - R0,75 - 12 - 50/75 - (T1-S7) - <0,5/1/1,5° - Z 2	1,5	4_6	0,5/1/1,5	0,75	1	7	12	50/75	30	2
Ø1,5 - Ø4_6 - R0,75 - 13,5 - 50/75 - (T1-S8) - <0,5/1/1,5° - Z 2	1,5	4_6	0,5/1/1,5	0,75	1	8	13,5	50/75	30	2
Ø1,5 - Ø4_6 - R0,75 - 15 - 50/75 - (T1-S9) - <0,5/1/1,5° - Z 2	1,5	4_6	0,5/1/1,5	0,75	1	9	15	50/75	30	2
Ø1,5 - Ø4_6 - R0,75 - 16,5 - 50/75 - (T1-S10) - <0,5/1/1,5° - Z	1,5	4_6	0,5/1/1,5	0,75	1	10	16,5	50/75	30	
Ø1,5 - Ø4_6 - R0,75 - 18 - 50/75 - (T1-S11) - <0,5/1/1,5° - Z 2	1,5	4_6	0,5/1/1,5	0,75	1	11	18	50/75	30	2
Ø1,5 - Ø4_6 - R0,75 - 19,5 - 50/75 - (T1-S12) - <0,5/1/1,5° - Z 2	1,5	4_6	0,5/1/1,5	0,75	1	12	19,5	50/75	30	2

TUTTI I NOSTRI UTENSILI SONO PERSONALIZZABILI IN OGNI PARAMENTRO

Vai a pagina 36 per scoprirne come chiedere i tuoi utensili personalizzati!



PARAMETRI CONSIGLIATI

S	16500
F	900
PP	0,035/0,08

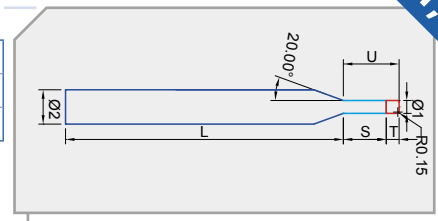

Ø1,5 TORICHE A 2 DIAMETRI

CODE: - Ø1-Ø2-R-U-L - (T-S) - < - z	DIAM.1	DIAM.2	0°-0,5°-1°-1,5°-2°...	RAGGIO	1XD-2XD-3XD SHARP	1XD-2XD-3XD Ø1/40	HELPFUL T+S	50/75 100/125	ELIX	FLUTES
	Ø 1	Ø 2	TAPER - (<°)	R	T	S	U	L	E 0°	Z
Ø1,5 - Ø4,6 - R0,1/0,25/0,5 - 6 - 50/75 - (T1-S3) <0° - Z 2_3	1,5	4,6	0	0,1/0,25/0,5	1	3	6	50/75	30	2_3
Ø1,5 - Ø4,6 - R0,1/0,25/0,5 - 7,5 - 50/75 - (T1-S4) <0° - Z 2_3	1,5	4,6	0	0,1/0,25/0,5	1	4	7,5	50/75	30	2_3
Ø1,5 - Ø4,6 - R0,1/0,25/0,5 - 9 - 50/75 - (T1-S5) <0° - Z 2_3	1,5	4,6	0	0,1/0,25/0,5	1	5	9	50/75	30	2_3
Ø1,5 - Ø4,6 - R0,1/0,25/0,5 - 10,5 - 50/75 - (T1-S6) <0° - Z 2_3	1,5	4,6	0	0,1/0,25/0,5	1	6	10,5	50/75	30	2_3
Ø1,5 - Ø4,6 - R0,1/0,25/0,5 - 12 - 50/75 - (T1-S7) <0° - Z 2_3	1,5	4,6	0	0,1/0,25/0,5	1	7	12	50/75	30	2_3
Ø1,5 - Ø4,6 - R0,1/0,25/0,5 - 13,5 - 50/75 - (T1-S8) <0° - Z 2_3	1,5	4,6	0	0,1/0,25/0,5	1	8	13,5	50/75	30	2_3
Ø1,5 - Ø4,6 - R0,1/0,25/0,5 - 15 - 50/75 - (T1-S9) <0° - Z 2_3	1,5	4,6	0	0,1/0,25/0,5	1	9	15	50/75	30	2_3
Ø1,5 - Ø4,6 - R0,1/0,25/0,5 - 16,5 - 50/75 - (T1-S10) <0° - Z 2_3	1,5	4,6	0	0,1/0,25/0,5	1	10	16,5	50/75	30	2_3
Ø1,5 - Ø4,6 - R0,1/0,25/0,5 - 18 - 50/75 - (T1-S11) <0° - Z 2_3	1,5	4,6	0	0,1/0,25/0,5	1	11	18	50/75	30	2_3
Ø1,5 - Ø4,6 - R0,1/0,25/0,5 - 19,5 - 50/75 - (T1-S12) <0° - Z 2_3	1,5	4,6	0	0,1/0,25/0,5	1	12	19,5	50/75	30	2_3

TUTTI I NOSTRI UTENSILI SONO PERSONALIZZABILI IN OGNI PARAMENTRO

Vai a pagina 36 per scoprirne come chiedere i tuoi utensili personalizzati!



PARAMETRI CONSIGLIATI

S	16500
F	900
PP	0,035/0,08

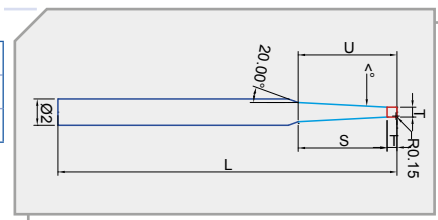

Ø1,5 TORICHE CONICHE

CODE: - Ø1-Ø2-R-U-L - (T-S) - < - z	DIAM.1	DIAM.2	0°-0,5°-1°-1,5°-2°...	RAGGIO	1XD-2XD-3XD SHARP	1XD-2XD-3XD Ø1/40	HELPFUL T+S	50/75 100/125	ELIX	FLUTES
	Ø 1	Ø 2	TAPER - (<°)	R	T	S	U	L	E 0°	Z
Ø1,5 - Ø4,6 - R0,1/0,25/0,5 - 6 - 50/75 - (T1-S3) - <0,5/1/1,5° - Z 2_3	1,5	4,6	0,5/1/1,5	0,1/0,25/0,5	1	3	6	50/75	30	2_3
Ø1,5 - Ø4,6 - R0,1/0,25/0,5 - 7,5 - 50/75 - (T1-S4) - <0,5/1/1,5° - Z 2_3	1,5	4,6	0,5/1/1,5	0,1/0,25/0,5	1	4	7,5	50/75	30	2_3
Ø1,5 - Ø4,6 - R0,1/0,25/0,5 - 9 - 50/75 - (T1-S5) - <0,5/1/1,5° - Z 2_3	1,5	4,6	0,5/1/1,5	0,1/0,25/0,5	1	5	9	50/75	30	2_3
Ø1,5 - Ø4,6 - R0,1/0,25/0,5 - 10,5 - 50/75 - (T1-S6) - <0,5/1/1,5° - Z 2_3	1,5	4,6	0,5/1/1,5	0,1/0,25/0,5	1	6	10,5	50/75	30	2_3
Ø1,5 - Ø4,6 - R0,1/0,25/0,5 - 12 - 50/75 - (T1-S7) - <0,5/1/1,5° - Z 2_3	1,5	4,6	0,5/1/1,5	0,1/0,25/0,5	1	7	12	50/75	30	2_3
Ø1,5 - Ø4,6 - R0,1/0,25/0,5 - 13,5 - 50/75 - (T1-S8) - <0,5/1/1,5° - Z 2_3	1,5	4,6	0,5/1/1,5	0,1/0,25/0,5	1	8	13,5	50/75	30	2_3
Ø1,5 - Ø4,6 - R0,1/0,25/0,5 - 15 - 50/75 - (T1-S9) - <0,5/1/1,5° - Z 2_3	1,5	4,6	0,5/1/1,5	0,1/0,25/0,5	1	9	15	50/75	30	2_3
Ø1,5 - Ø4,6 - R0,1/0,25/0,5 - 16,5 - 50/75 - (T1-S10) - <0,5/1/1,5° - Z 2_3	1,5	4,6	0,5/1/1,5	0,1/0,25/0,5	1	10	16,5	50/75	30	2_3
Ø1,5 - Ø4,6 - R0,1/0,25/0,5 - 18 - 50/75 - (T1-S11) - <0,5/1/1,5° - Z 2_3	1,5	4,6	0,5/1/1,5	0,1/0,25/0,5	1	11	18	50/75	30	2_3
Ø1,5 - Ø4,6 - R0,1/0,25/0,5 - 19,5 - 50/75 - (T1-S12) - <0,5/1/1,5° - Z 2_3	1,5	4,6	0,5/1/1,5	0,1/0,25/0,5	1	12	19,5	50/75	30	2_3

TUTTI I NOSTRI UTENSILI SONO PERSONALIZZABILI IN OGNI PARAMENTRO

Vai a pagina 36 per scoprirne come chiedere i tuoi utensili personalizzati!

DIAMETRO > 2 <



Ø2 CILINDRICHE A 2 DIAMETRI

PARAMETRI
CONSIGLIATI

S	14000
F	1500
PP	0,05/0,1

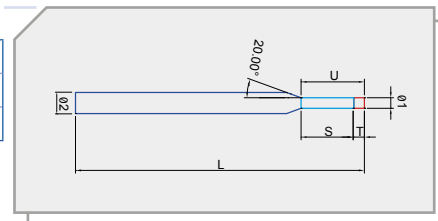

CODE: - Ø1-Ø2-R-U-L - (T-S) - < - z	DIAM.1	DIAM.2	0°-0,5°-1°-1,5°-2°...	RAGGIO	1XD-2XD-3XD SHARP	1XD-2XD-3XD Ø1/40	HELPFUL T+S	50/75 100/125	ELIX	FLUTES
	Ø 1	Ø 2	TAPER - (<°)	R	T	S	U	L	E 0°	Z
Ø2 - Ø4_6 - R0 - 8 - 50/75 - (T1-S3) - <0° - Z 2_3	2	4_6	0	0	1	3	8	50/75	30	2_3
Ø2 - Ø4_6 - R0 - 10 - 50/75 - (T1-S4) - <0° - Z 2_3	2	4_6	0	0	1	4	10	50/75	30	2_3
Ø2 - Ø4_6 - R0 - 12 - 50/75 - (T1-S5) - <0° - Z 2_3	2	4_6	0	0	1	5	12	50/75	30	2_3
Ø2 - Ø4_6 - R0 - 14 - 50/75 - (T1-S6) - <0° - Z 2_3	2	4_6	0	0	1	6	14	50/75	30	2_3
Ø2 - Ø4_6 - R0 - 16 - 50/75 - (T1-S7) - <0° - Z 2_3	2	4_6	0	0	1	7	16	50/75	30	2_3
Ø2 - Ø4_6 - R0 - 18 - 50/75 - (T1-S8) - <0° - Z 2_3	2	4_6	0	0	1	8	18	50/75	30	2_3
Ø2 - Ø4_6 - R0 - 20 - 50/75 - (T1-S9) - <0° - Z 2_3	2	4_6	0	0	1	9	20	50/75	30	2_3
Ø2 - Ø4_6 - R0 - 22 - 50/75 - (T1-S10) - <0° - Z 2_3	2	4_6	0	0	1	10	22	50/75	30	2_3
Ø2 - Ø4_6 - R0 - 24 - 50/75 - (T1-S11) - <0° - Z 2_3	2	4_6	0	0	1	11	24	50/75	30	2_3
Ø2 - Ø4_6 - R0 - 26 - 50/75 - (T1-S12) - <0° - Z 2_3	2	4_6	0	0	1	12	26	50/75	30	2_3

TUTTI I NOSTRI UTENSILI SONO PERSONALIZZABILI IN OGNI PARAMENTRO

Vai a pagina 36 per scoprirne come chiedere i tuoi utensili personalizzati!



Ø2 CILINDRICHE CONICHE

PARAMETRI
CONSIGLIATI

S	14000
F	1500
PP	0,05/0,1

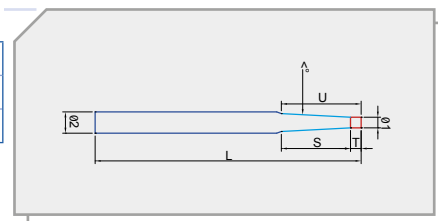

CODE: - Ø1-Ø2-R-U-L - (T-S) - < - z	DIAM.1	DIAM.2	0°-0,5°-1°-1,5°-2°...	RAGGIO	1XD-2XD-3XD SHARP	1XD-2XD-3XD Ø1/40	HELPFUL T+S	50/75 100/125	ELIX	FLUTES
	Ø 1	Ø 2	TAPER - (<°)	R	T	S	U	L	E 0°	Z
Ø2 - Ø4_6 - R0 - 8 - 75/100 - (T1-S3) - <0,5/1/1,5° - Z 2_3	2	4_6	0,5/1/1,5	0	1	3	8	75/100	30	2_3
Ø2 - Ø4_6 - R0 - 10 - 75/100 - (T1-S4) - <0,5/1/1,5° - Z 2_3	2	4_6	0,5/1/1,5	0	1	4	10	75/100	30	2_3
Ø2 - Ø4_6 - R0 - 12 - 75/100 - (T1-S5) - <0,5/1/1,5° - Z 2_3	2	4_6	0,5/1/1,5	0	1	5	12	75/100	30	2_3
Ø2 - Ø4_6 - R0 - 14 - 75/100 - (T1-S6) - <0,5/1/1,5° - Z 2_3	2	4_6	0,5/1/1,5	0	1	6	14	75/100	30	2_3
Ø2 - Ø4_6 - R0 - 16 - 75/100 - (T1-S7) - <0,5/1/1,5° - Z 2_3	2	4_6	0,5/1/1,5	0	1	7	16	75/100	30	2_3
Ø2 - Ø4_6 - R0 - 18 - 75/100 - (T1-S8) - <0,5/1/1,5° - Z 2_3	2	4_6	0,5/1/1,5	0	1	8	18	75/100	30	2_3
Ø2 - Ø4_6 - R0 - 20 - 75/100 - (T1-S9) - <0,5/1/1,5° - Z 2_3	2	4_6	0,5/1/1,5	0	1	9	20	75/100	30	2_3
Ø2 - Ø4_6 - R0 - 22 - 75/100 - (T1-S10) - <0,5/1/1,5° - Z 2_3	2	4_6	0,5/1/1,5	0	1	10	22	75/100	30	2_3
Ø2 - Ø4_6 - R0 - 24 - 75/100 - (T1-S11) - <0,5/1/1,5° - Z 2_3	2	4_6	0,5/1/1,5	0	1	11	24	75/100	30	2_3
Ø2 - Ø4_6 - R0 - 26 - 75/100 - (T1-S12) - <0,5/1/1,5° - Z 2_3	2	4_6	0,5/1/1,5	0	1	12	26	75/100	30	2_3

TUTTI I NOSTRI UTENSILI SONO PERSONALIZZABILI IN OGNI PARAMENTRO

Vai a pagina 36 per scoprirne come chiedere i tuoi utensili personalizzati!



PARAMETRI CONSIGLIATI

S	15000
F	1200
PP	0,05/0,1

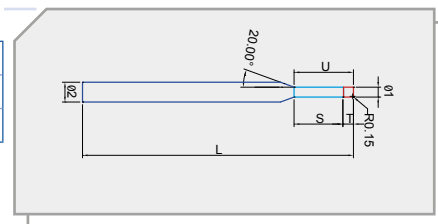

Ø2 SFERICHE A 2 DIAMETRI

CODE: - Ø1-Ø2-R-U-L - (T-S) - < - z	DIAM.1	DIAM.2	0°-0.5°-1°-1.5°-2°...	RAGGIO	1XD-2XD-3XD SHARP	1XD-2XD-3XD Ø1/40	HELPFUL T+S	50/75 100/125	ELIX	FLUTES
	Ø 1	Ø 2	TAPER - (<°)	R	T	S	U	L	E 0°	Z
Ø2 - Ø4_6 - R1 - 8 - 50/75 - (T1-S3) - <0° - Z 2	2	4_6	0	1	1	3	8	50/75	30	2
Ø2 - Ø4_6 - R1 - 10 - 50/75 - (T1-S4) - <0° - Z 2	2	4_6	0	1	1	4	10	50/75	30	2
Ø2 - Ø4_6 - R1 - 12 - 50/75 - (T1-S5) - <0° - Z 2	2	4_6	0	1	1	5	12	50/75	30	2
Ø2 - Ø4_6 - R1 - 14 - 50/75 - (T1-S6) - <0° - Z 2	2	4_6	0	1	1	6	14	50/75	30	2
Ø2 - Ø4_6 - R1 - 16 - 50/75 - (T1-S7) - <0° - Z 2	2	4_6	0	1	1	7	16	50/75	30	2
Ø2 - Ø4_6 - R1 - 18 - 50/75 - (T1-S8) - <0° - Z 2	2	4_6	0	1	1	8	18	50/75	30	2
Ø2 - Ø4_6 - R1 - 20 - 50/75 - (T1-S9) - <0° - Z 2	2	4_6	0	1	1	9	20	50/75	30	2
Ø2 - Ø4_6 - R1 - 22 - 50/75 - (T1-S10) - <0° - Z 2	2	4_6	0	1	1	10	22	50/75	30	2
Ø2 - Ø4_6 - R1 - 24 - 50/75 - (T1-S11) - <0° - Z 2	2	4_6	0	1	1	11	24	50/75	30	2
Ø2 - Ø4_6 - R1 - 26 - 50/75 - (T1-S12) - <0° - Z 2	2	4_6	0	1	1	12	26	50/75	30	2

TUTTI I NOSTRI UTENSILI SONO PERSONALIZZABILI IN OGNI PARAMENTRO

Vai a pagina 36 per scoprirne come chiedere i tuoi utensili personalizzati!



PARAMETRI CONSIGLIATI

S	15000
F	1200
PP	0,05/0,1

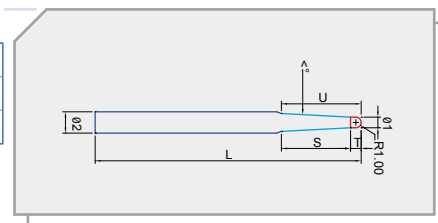

Ø2 SFERICHE CONICHE

CODE: - Ø1-Ø2-R-U-L - (T-S) - < - z	DIAM.1	DIAM.2	0°-0.5°-1°-1.5°-2°...	RAGGIO	1XD-2XD-3XD SHARP	1XD-2XD-3XD Ø1/40	HELPFUL T+S	50/75 100/125	ELIX	FLUTES
	Ø 1	Ø 2	TAPER - (<°)	R	T	S	U	L	E 0°	Z
Ø2 - Ø4_6 - R1 - 8 - 75/100 - (T1-S3) - <0,5/1/1,5° - Z 2	2	4_6	0,5/1/1,5	1	1	3	8	75/100	30	2
Ø2 - Ø4_6 - R1 - 10 - 75/100 - (T1-S4) - <0,5/1/1,5° - Z 2	2	4_6	0,5/1/1,5	1	1	4	10	75/100	30	2
Ø2 - Ø4_6 - R1 - 12 - 75/100 - (T1-S5) - <0,5/1/1,5° - Z 2	2	4_6	0,5/1/1,5	1	1	5	12	75/100	30	2
Ø2 - Ø4_6 - R1 - 14 - 75/100 - (T1-S6) - <0,5/1/1,5° - Z 2	2	4_6	0,5/1/1,5	1	1	6	14	75/100	30	2
Ø2 - Ø4_6 - R1 - 16 - 75/100 - (T1-S7) - <0,5/1/1,5° - Z 2	2	4_6	0,5/1/1,5	1	1	7	16	75/100	30	2
Ø2 - Ø4_6 - R1 - 18 - 75/100 - (T1-S8) - <0,5/1/1,5° - Z 2	2	4_6	0,5/1/1,5	1	1	8	18	75/100	30	2
Ø2 - Ø4_6 - R1 - 20 - 75/100 - (T1-S9) - <0,5/1/1,5° - Z 2	2	4_6	0,5/1/1,5	1	1	9	20	75/100	30	2
Ø2 - Ø4_6 - R1 - 22 - 75/100 - (T1-S10) - <0,5/1/1,5° - Z	2	4_6	0,5/1/1,5	1	1	10	22	75/100	30	
Ø2 - Ø4_6 - R1 - 24 - 75/100 - (T1-S11) - <0,5/1/1,5° - Z 2	2	4_6	0,5/1/1,5	1	1	11	24	75/100	30	2
Ø2 - Ø4_6 - R1 - 26 - 75/100 - (T1-S12) - <0,5/1/1,5° - Z 2	2	4_6	0,5/1/1,5	1	1	12	26	75/100	30	2

TUTTI I NOSTRI UTENSILI SONO PERSONALIZZABILI IN OGNI PARAMENTRO

Vai a pagina 36 per scoprirne come chiedere i tuoi utensili personalizzati!

Ø2



PARAMETRI CONSIGLIATI

S	14000
F	1500
PP	0,05/0,1

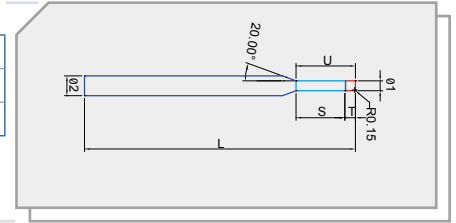

Ø2 TORICHE A 2 DIAMETRI

CODE: - Ø1-Ø2-R-U-L - (T-S) - <- Z	DIAM.1	DIAM.2	0°-0,5°-1°-1,5°-2°...	RAGGIO	1XD-2XD-3XD SHARP	1XD-2XD-3XD Ø1/40	HELPFUL T+S	50/75 100/125	ELIX	FLUTES
	Ø 1	Ø 2	TAPER - (<°)	R	T	S	U	L	E 0°	Z
Ø2 - Ø4_6 - R0,1/0,25/0,5 - 8 - 50/75 - (T1-S3) - <0° - Z 2_3	2	4_6	0	0,1/0,25/0,5	1	3	8	50/75	30	2_3
Ø2 - Ø4_6 - R0,1/0,25/0,5 - 10 - 50/75 - (T1-S4) - <0° - Z 2_3	2	4_6	0	0,1/0,25/0,5	1	4	10	50/75	30	2_3
Ø2 - Ø4_6 - R0,1/0,25/0,5 - 12 - 50/75 - (T1-S5) - <0° - Z 2_3	2	4_6	0	0,1/0,25/0,5	1	5	12	50/75	30	2_3
Ø2 - Ø4_6 - R0,1/0,25/0,5 - 14 - 75 - (T1-S6) - <0° - Z 2_3	2	4_6	0	0,1/0,25/0,5	1	6	14	75	30	2_3
Ø2 - Ø4_6 - R0,1/0,25/0,5 - 16 - 75 - (T1-S7) - <0° - Z 2_3	2	4_6	0	0,1/0,25/0,5	1	7	16	75	30	2_3
Ø2 - Ø4_6 - R0,1/0,25/0,5 - 18 - 75 - (T1-S8) - <0° - Z 2_3	2	4_6	0	0,1/0,25/0,5	1	8	18	75	30	2_3
Ø2 - Ø4_6 - R0,1/0,25/0,5 - 20 - 75 - (T1-S9) - <0° - Z 2_3	2	4_6	0	0,1/0,25/0,5	1	9	20	75	30	2_3
Ø2 - Ø4_6 - R0,1/0,25/0,5 - 22 - 75 - (T1-S10) - <0° - Z 2_3	2	4_6	0	0,1/0,25/0,5	1	10	22	75	30	2_3
Ø2 - Ø4_6 - R0,1/0,25/0,5 - 24 - 75 - (T1-S11) - <0° - Z 2_3	2	4_6	0	0,1/0,25/0,5	1	11	24	75	30	2_3
Ø2 - Ø4_6 - R0,1/0,25/0,5 - 26 - 75 - (T1-S12) - <0° - Z 2_3	2	4_6	0	0,1/0,25/0,5	1	12	26	75	30	2_3

TUTTI I NOSTRI UTENSILI SONO PERSONALIZZABILI IN OGNI PARAMENTRO

Vai a pagina 36 per scoprirne come chiedere i tuoi utensili personalizzati!



PARAMETRI CONSIGLIATI

S	14000
F	1500
PP	0,05/0,1

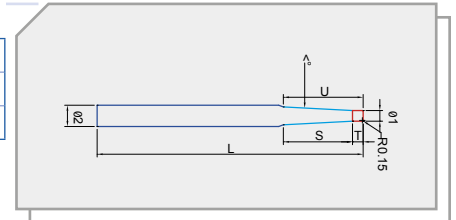

Ø2 TORICHE CONICHE

CODE: - Ø1-Ø2-R-U-L - (T-S) - <- Z	DIAM.1	DIAM.2	0°-0,5°-1°-1,5°-2°...	RAGGIO	1XD-2XD-3XD SHARP	1XD-2XD-3XD Ø1/40	HELPFUL T+S	50/75 100/125	ELIX	FLUTES
	Ø 1	Ø 2	TAPER - (<°)	R	T	S	U	L	E 0°	Z
Ø2 - Ø4_6 - R0,1/0,25/0,5 - 8 - 75 - (T1-S3) - <0,5/1/1,5° - Z 2_3	2	4_6	0,5/1/1,5	0,1/0,25/0,5	1	3	8	75	30	2_3
Ø2 - Ø4_6 - R0,1/0,25/0,5 - 10 - 75 - (T1-S4) - <0,5/1/1,5° - Z 2_3	2	4_6	0,5/1/1,5	0,1/0,25/0,5	1	4	10	75	30	2_3
Ø2 - Ø4_6 - R0,1/0,25/0,5 - 12 - 75 - (T1-S5) - <0,5/1/1,5° - Z 2_3	2	4_6	0,5/1/1,5	0,1/0,25/0,5	1	5	12	75	30	2_3
Ø2 - Ø4_6 - R0,1/0,25/0,5 - 14 - 75 - (T1-S6) - <0,5/1/1,5° - Z 2_3	2	4_6	0,5/1/1,5	0,1/0,25/0,5	1	6	14	75	30	2_3
Ø2 - Ø4_6 - R0,1/0,25/0,5 - 16 - 75 - (T1-S7) - <0,5/1/1,5° - Z 2_3	2	4_6	0,5/1/1,5	0,1/0,25/0,5	1	7	16	75	30	2_3
Ø2 - Ø4_6 - R0,1/0,25/0,5 - 18 - 75 - (T1-S8) - <0,5/1/1,5° - Z 2_3	2	4_6	0,5/1/1,5	0,1/0,25/0,5	1	8	18	75	30	2_3
Ø2 - Ø4_6 - R0,1/0,25/0,5 - 20 - 75 - (T1-S9) - <0,5/1/1,5° - Z 2_3	2	4_6	0,5/1/1,5	0,1/0,25/0,5	1	9	20	75	30	2_3
Ø2 - Ø4_6 - R0,1/0,25/0,5 - 22 - 75 - (T1-S10) - <0,5/1/1,5° - Z 2_3	2	4_6	0,5/1/1,5	0,1/0,25/0,5	1	10	22	75	30	2_3
Ø2 - Ø4_6 - R0,1/0,25/0,5 - 24 - 75 - (T1-S11) - <0,5/1/1,5° - Z 2_3	2	4_6	0,5/1/1,5	0,1/0,25/0,5	1	11	24	75	30	2_3
Ø2 - Ø4_6 - R0,1/0,25/0,5 - 26 - 75 - (T1-S12) - <0,5/1/1,5° - Z 2_3	2	4_6	0,5/1/1,5	0,1/0,25/0,5	1	12	26	75	30	2_3

TUTTI I NOSTRI UTENSILI SONO PERSONALIZZABILI IN OGNI PARAMENTRO

Vai a pagina 36 per scoprirne come chiedere i tuoi utensili personalizzati!

DIAMETRO > 3 <



Ø3 CILINDRICHE A 2 DIAMETRI

PARAMETRI CONSIGLIATI

S	11000
F	1600/2000
PP	0,05/0,12

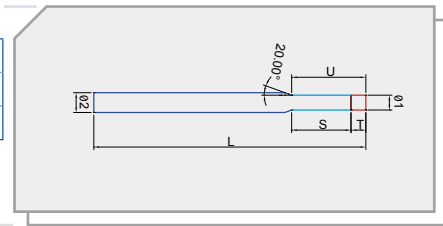

CODE: - Ø1-Ø2-R-U-L - (T-S) - < - z	DIAM.1	DIAM.2	0°-0,5°-1°-1,5°-2°...	RAGGIO	1XD-2XD-3XD SHARP	1XD-2XD-3XD Ø1/40	HELPFUL T+S	50/75 100/125	ELIX	FLUTES
	Ø 1	Ø 2	TAPER - (<°)	R	T	S	U	L	E 0°	Z
Ø3 - Ø4 - R0 - 12 - 50/75 - (T1-S3) - <0° - Z 4	3	4	0	0	1	3	12	50/75	35	4
Ø3 - Ø4 - R0 - 15 - 50/75 - (T1-S4) - <0° - Z 4	3	4	0	0	1	4	15	50/75	35	4
Ø3 - Ø4 - R0 - 18 - 50/75 - (T1-S5) - <0° - Z 4	3	4	0	0	1	5	18	50/75	35	4
Ø3 - Ø4 - R0 - 21 - 75 - (T1-S6) - <0° - Z 4	3	4	0	0	1	6	21	75	35	4
Ø3 - Ø4 - R0 - 24 - 75 - (T1-S7) - <0° - Z 4	3	4	0	0	1	7	24	75	35	4
Ø3 - Ø4 - R0 - 27 - 75 - (T1-S8) - <0° - Z 4	3	4	0	0	1	8	27	75	35	4
Ø3 - Ø4 - R0 - 30 - 75 - (T1-S9) - <0° - Z 4	3	4	0	0	1	9	30	75	35	4



Ø3 CILINDRICHE SCARICATE

PARAMETRI CONSIGLIATI

S	11000
F	1600/2000
PP	0,05/0,12

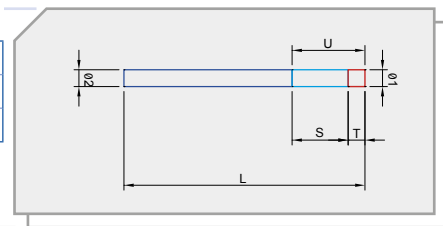

CODE: - Ø1-Ø2-R-U-L - (T-S) - < - z	DIAM.1	DIAM.2	0°-0,5°-1°-1,5°-2°...	RAGGIO	1XD-2XD-3XD SHARP	1XD-2XD-3XD Ø1/40	HELPFUL T+S	50/75 100/125	ELIX	FLUTES
	Ø 1	Ø 2	TAPER - (<°)	R	T	S	U	L	E 0°	Z
Ø3 - Ø3 - R0 - 6 - 50/75 - (T1-S1) - <0° - Z 4	3	3	0	0	1	1	6	50/75	35°	4
Ø3 - Ø3 - R0 - 9 - 50/75 - (T1-S2) - <0° - Z 4	3	3	0	0	1	2	9	50/75	35	4
Ø3 - Ø3 - R0 - 12 - 50/75 - (T1-S3) - <0° - Z 4	3	3	0	0	1	3	12	50/75	35	4
Ø3 - Ø3 - R0 - 15 - 50/75 - (T1-S4) - <0° - Z 4	3	3	0	0	1	4	15	50/75	35	4
Ø3 - Ø3 - R0 - 9 - 50/75 - (T2-S1) - <0° - Z 4	3	3	0	0	2	1	9	50/75	35	4
Ø3 - Ø3 - R0 - 12 - 50/75 - (T2-S2) - <0° - Z 4	3	3	0	0	2	2	12	50/75	35	4
Ø3 - Ø3 - R0 - 15 - 50/75 - (T3-S2) - <0° - Z 4	3	3	0	0	3	2	15	50/75	35	4



Ø3 CILINDRICHE STANDARD

PARAMETRI CONSIGLIATI

S	11000
F	1600/2000
PP	0,05/0,12

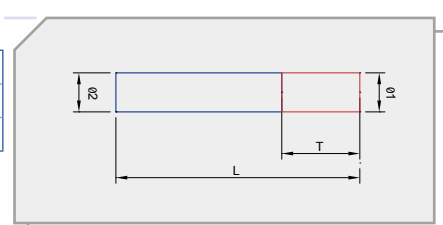

CODE: - Ø1-Ø2-R-U-L - (T-S) - < - z	DIAM.1	DIAM.2	0°-0,5°-1°-1,5°-2°...	RAGGIO	1XD-2XD-3XD SHARP	1XD-2XD-3XD Ø1/40	HELPFUL T+S	50/75 100/125	ELIX	FLUTES
	Ø 1	Ø 2	TAPER - (<°)	R	T	S	U	L	E 0°	Z
Ø3 - Ø3 - R0 - 3 - 50/75 - (T1-S0) - <0° - Z 4	3	3	0	0	1	0	3	50/75	35	4
Ø3 - Ø3 - R0 - 6 - 50/75 - (T2-S0) - <0° - Z 4	3	3	0	0	2	0	6	50/75	35	4
Ø3 - Ø3 - R0 - 9 - 50/75 - (T3-S0) - <0° - Z 4	3	3	0	0	3	0	9	50/75	35	4

TUTTI I NOSTRI UTENSILI SONO PERSONALIZZABILI IN OGNI PARAMENTRO Vai a pagina 36 per scoprire come chiedere i tuoi utensili personalizzati!

Ø3



Ø3 SFERICHE STANDARD

PARAMETRI CONSIGLIATI

S	12500
F	1500/1800
PP	0,05/0,12

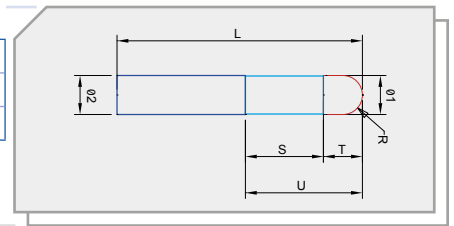

CODE: - Ø1-Ø2-R-U-L - (T-S) - < - z	DIAM.1	DIAM.2	0°-0,5°-1°-1,5°-2°...	RAGGIO	1XD-2XD-3XD SHARP	1XD-2XD-3XD Ø1/40	HELPFUL T+S	50/75 100/125	ELIX	FLUTES
	Ø 1	Ø 2	TAPER - (<°)	R	T	S	U	L	E 0°	Z
Ø3 - Ø3 - R1,5 - 6 - 50/75 - (T1-S1) - <0° - Z 2	3	3	0	1,5	1	1	6	50/75	30	2
Ø3 - Ø3 - R1,5 - 9 - 50/75 - (T1-S2) - <0° - Z 2	3	3	0	1,5	1	2	9	50/75	30	2
Ø3 - Ø3 - R1,5 - 12 - 50/75 - (T1-S3) - <0° - Z 2	3	3	0	1,5	1	3	12	50/75	30	2
Ø3 - Ø3 - R1,5 - 15 - 50/75 - (T1-S4) - <0° - Z 2	3	3	0	1,5	1	4	15	50/75	30	2

TUTTI I NOSTRI UTENSILI SONO PERSONALIZZABILI IN OGNI PARAMENTRO

Vai a pagina 36 per scoprire come chiedere i tuoi utensili personalizzati!



Ø3 SFERICHE CONICHE

PARAMETRI CONSIGLIATI

S	12500
F	1500/1800
PP	0,05/0,12

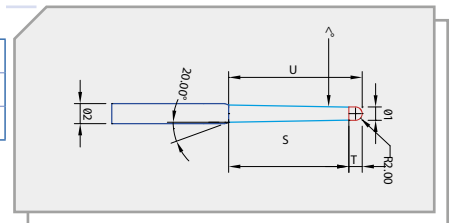

CODE: - Ø1-Ø2-R-U-L - (T-S) - < - z	DIAM.1	DIAM.2	0°-0,5°-1°-1,5°-2°...	RAGGIO	1XD-2XD-3XD SHARP	1XD-2XD-3XD Ø1/40	HELPFUL T+S	50/75 100/125	ELIX	FLUTES
	Ø 1	Ø 2	TAPER - (<°)	R	T	S	U	L	E 0°	Z
Ø3 - Ø4_6 - R1,5 - 12 - 75/100 - (T1-S3) - <0,5/1/1,5° - Z 4	3	4_6	0,5/1/1,5	1,5	1	3	12	75/100	35	4
Ø3 - Ø4_6 - R1,5 - 15 - 75/100 - (T1-S4) - <0,5/1/1,5° - Z 4	3	4_6	0,5/1/1,5	1,5	1	4	15	75/100	35	4
Ø3 - Ø4_6 - R1,5 - 18 - 75/100 - (T1-S5) - <0,5/1/1,5° - Z 4	3	4_6	0,5/1/1,5	1,5	1	5	18	75/100	35	4
Ø3 - Ø4_6 - R1,5 - 21 - 75/100 - (T1-S6) - <0,5/1/1,5° - Z 4	3	4_6	0,5/1/1,5	1,5	1	6	21	75/100	35	4
Ø3 - Ø4_6 - R1,5 - 24 - 75/100 - (T1-S7) - <0,5/1/1,5° - Z 4	3	4_6	0,5/1/1,5	1,5	1	7	24	75/100	35	4
Ø3 - Ø4_6 - R1,5 - 27 - 75/100 - (T1-S8) - <0,5/1/1,5° - Z 4	3	4_6	0,5/1/1,5	1,5	1	8	27	75/100	35	4
Ø3 - Ø4_6 - R1,5 - 30 - 75/100 - (T1-S9) - <0,5/1/1,5° - Z 4	3	4_6	0,5/1/1,5	1,5	1	9	30	75/100	35	4

TUTTI I NOSTRI UTENSILI SONO PERSONALIZZABILI IN OGNI PARAMENTRO

Vai a pagina 36 per scoprire come chiedere i tuoi utensili personalizzati!



PARAMETRI CONSIGLIATI

S	11000
F	1600/2000
PP	0,05/0,12

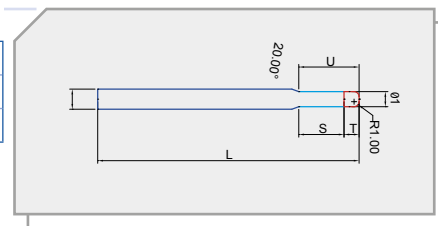

Ø3 TORICHE A 2 DIAMETRI

CODE: - Ø1-Ø2-R-U-L - (T-S) - < - z	DIAM.1	DIAM.2	0°-0,5°-1°-1,5°-2°...	RAGGIO	1XD-2XD-3XD SHARP	1XD-2XD-3XD Ø1/40	HELPPFUL T+S	50/75 100/125	ELIX	FLUTES
	Ø 1	Ø 2	TAPER - (<°)	R	T	S	U	L	E 0°	Z
Ø3 - Ø4_6 - R0,5/1 - 12 - 50/75 - (T1-S3) - <0° - Z 4	3	4_6	0	0,5/1	1	3	12	50/75	35	4
Ø3 - Ø4_6 - R0,5/1 - 15 - 50/75 - (T1-S4) - <0° - Z 4	3	4_6	0	0,5/1	1	4	15	50/75	35	4
Ø3 - Ø4_6 - R0,5/1 - 18 - 50/75 - (T1-S5) - <0° - Z 4	3	4_6	0	0,5/1	1	5	18	50/75	35	4
Ø3 - Ø4_6 - R0,5/1 - 21 - 75/100 - (T1-S6) - <0° - Z 4	3	4_6	0	0,5/1	1	6	21	75/100	35	4
Ø3 - Ø4_6 - R0,5/1 - 24 - 75/100 - (T1-S7) - <0° - Z 4	3	4_6	0	0,5/1	1	7	24	75/100	35	4
Ø3 - Ø4_6 - R0,5/1 - 27 - 75/100 - (T1-S8) - <0° - Z 4	3	4_6	0	0,5/1	1	8	27	75/100	35	4
Ø3 - Ø4_6 - R0,5/1 - 30 - 75/100 - (T1-S9) - <0° - Z 4	3	4_6	0	0,5/1	1	9	30	75/100	35	4

TUTTI I NOSTRI UTENSILI SONO PERSONALIZZABILI IN OGNI PARAMENTRO

Vai a pagina 36 per scoprirne come chiedere i tuoi utensili personalizzati!



PARAMETRI CONSIGLIATI

S	11000
F	1600/2000
PP	0,05/0,12

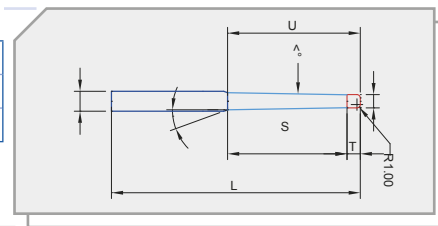

Ø3 TORICHE CONICHE

CODE: - Ø1-Ø2-R-U-L - (T-S) - < - z	DIAM.1	DIAM.2	0°-0,5°-1°-1,5°-2°...	RAGGIO	1XD-2XD-3XD SHARP	1XD-2XD-3XD Ø1/40	HELPPFUL T+S	50/75 100/125	ELIX	FLUTES
	Ø 1	Ø 2	TAPER - (<°)	R	T	S	U	L	E 0°	Z
Ø3 - Ø4_6 - R0,5/1 - 12 - 75/100 - (T1-S3) - <0,5/1/1,5° - Z 4	3	4_6	0,5/1/1,5	0,5/1	1	3	12	75/100	35	4
Ø3 - Ø4_6 - R0,5/1 - 15 - 75/100 - (T1-S4) - <0,5/1/1,5° - Z 4	3	4_6	0,5/1/1,5	0,5/1	1	4	15	75/100	35	4
Ø3 - Ø4_6 - R0,5/1 - 18 - 75/100 - (T1-S5) - <0,5/1/1,5° - Z 4	3	4_6	0,5/1/1,5	0,5/1	1	5	18	75/100	35	4
Ø3 - Ø4_6 - R0,5/1 - 21 - 75/100 - (T1-S6) - <0,5/1/1,5° - Z 4	3	4_6	0,5/1/1,5	0,5/1	1	6	21	75/100	35	4
Ø3 - Ø4_6 - R0,5/1 - 24 - 75/100 - (T1-S7) - <0,5/1/1,5° - Z 4	3	4_6	0,5/1/1,5	0,5/1	1	7	24	75/100	35	4
Ø3 - Ø4_6 - R0,5/1 - 27 - 75/100 - (T1-S8) - <0,5/1/1,5° - Z 4	3	4_6	0,5/1/1,5	0,5/1	1	8	27	75/100	35	4
Ø3 - Ø4_6 - R0,5/1 - 30 - 75/100 - (T1-S9) - <0,5/1/1,5° - Z 4	3	4_6	0,5/1/1,5	0,5/1	1	9	30	75/100	35	4

TUTTI I NOSTRI UTENSILI SONO PERSONALIZZABILI IN OGNI PARAMENTRO

Vai a pagina 36 per scoprirne come chiedere i tuoi utensili personalizzati!

Ø3



Ø3 TORICHE STANDARD

PARAMETRI CONSIGLIATI

S	11000
F	1600/2000
PP	0,05/0,12

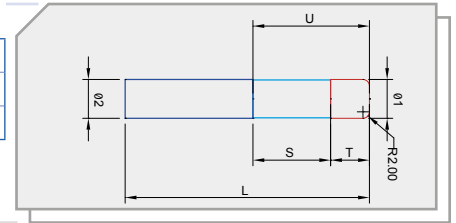

CODE: - Ø1-Ø2-R-U-L - (T-S) - < - z	DIAM.1	DIAM.2	0°-0,5°-1°-1,5°-2°...	RAGGIO	1XD-2XD-3XD SHARP	1XD-2XD-3XD Ø1/40	HELPPFUL T+S	50/75 100/125	ELIX	FLUTES
	Ø 1	Ø 2	TAPER - (<°)	R	T	S	U	L	E 0°	Z
Ø3 - Ø3 - R0,5/1 - 6 - 50/75 - (T1-S1) - <0° - Z 4	3	3	0	0,5/1	1	1	6	50/75	35	4
Ø3 - Ø3 - R0,5/1 - 9 - 50/75 - (T1-S2) - <0° - Z 4	3	3	0	0,5/1	1	2	9	50/75	35	4
Ø3 - Ø3 - R0,5/1 - 12 - 50/75 - (T1-S3) - <0° - Z 4	3	3	0	0,5/1	1	3	12	50/75	35	4
Ø3 - Ø3 - R0,5/1 - 15 - 50/75 - (T1-S4) - <0° - Z 4	3	3	0	0,5/1	1	4	15	50/75	35	4

TUTTI I NOSTRI UTENSILI SONO PERSONALIZZABILI IN OGNI PARAMENTRO

Vai a pagina 36 per scoprirne come chiedere i tuoi utensili personalizzati!



Ø3 CILINDRICHE CONICHE

PARAMETRI CONSIGLIATI

S	11000
F	1600/2000
PP	0,05/0,12

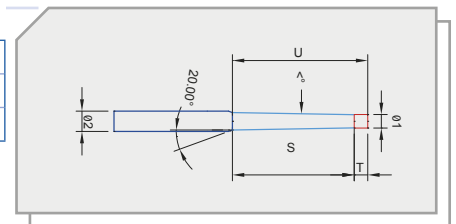

CODE: - Ø1-Ø2-R-U-L - (T-S) - < - z	DIAM.1	DIAM.2	0°-0,5°-1°-1,5°-2°...	RAGGIO	1XD-2XD-3XD SHARP	1XD-2XD-3XD Ø1/40	HELPPFUL T+S	50/75 100/125	ELIX	FLUTES
	Ø 1	Ø 2	TAPER - (<°)	R	T	S	U	L	E 0°	Z
Ø3 - Ø4_6 - R0 - 12 - 50/75 - (T1-S3) - <0,5/1/1,5° - Z 4	3	4,6	0,5/1/1,5	0	1	3	12	50/75	35	4
Ø3 - Ø4_6 - R0 - 15 - 50/75 - (T1-S4) - <0,5/1/1,5° - Z 4	3	4,6	0,5/1/1,5	0	1	4	15	50/75	35	4
Ø3 - Ø4_6 - R0 - 18 - 50/75 - (T1-S5) - <0,5/1/1,5° - Z 4	3	4,6	0,5/1/1,5	0	1	5	18	50/75	35	4
Ø3 - Ø4_6 - R0 - 21 - 50/75 - (T1-S6) - <0,5/1/1,5° - Z 4	3	4,6	0,5/1/1,5	0	1	6	21	50/75	35	4
Ø3 - Ø4_6 - R0 - 24 - 50/75 - (T1-S7) - <0,5/1/1,5° - Z 4	3	4,6	0,5/1/1,5	0	1	7	24	50/75	35	4
Ø3 - Ø4_6 - R0 - 27 - 50/75 - (T1-S8) - <0,5/1/1,5° - Z 4	3	4,6	0,5/1/1,5	0	1	8	27	50/75	35	4
Ø3 - Ø4_6 - R0 - 30 - 50/75 - (T1-S9) - <0,5/1/1,5° - Z 4	3	4,6	0,5/1/1,5	0	1	9	30	50/75	35	4

TUTTI I NOSTRI UTENSILI SONO PERSONALIZZABILI IN OGNI PARAMENTRO

Vai a pagina 36 per scoprirne come chiedere i tuoi utensili personalizzati!

DIAMETRO > 4 <



Ø4 CILINDRICHE SCARICATE

PARAMETRI CONSIGLIATI

S	10000
F	2500/3000
PP	0,06/0,15

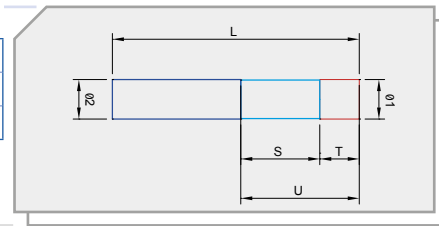

CODE: - Ø1-Ø2-R-U-L - (T-S) - < - z	DIAM.1	DIAM.2	0°-0,5°-1°-1,5°-2°...	RAGGIO	1XD-2XD-3XD SHARP	1XD-2XD-3XD Ø1/40	HELPFUL T+S	50/75 100/125	ELIX	FLUTES
	Ø 1	Ø 2	TAPER - (<°)	R	T	S	U	L	E 0°	Z
Ø4 - Ø4 - R0 - 8 - 50/75 - (T1-S1) - <0° - Z 4	4	4	0	0	1	1	8	50/75	35°	4
Ø4 - Ø4 - R0 - 12 - 50/75 - (T1-S2) - <0° - Z 4	4	4	0	0	1	2	12	50/75	35	4
Ø4 - Ø4 - R0 - 16 - 50/75 - (T1-S3) - <0° - Z 4	4	4	0	0	1	3	16	50/75	35	4
Ø4 - Ø4 - R0 - 20 - 50/75 - (T1-S4) - <0° - Z 4	4	4	0	0	1	4	20	50/75	35	4
Ø4 - Ø4 - R0 - 12 - 50/75 - (T2-S1) - <0° - Z 4	4	4	0	0	2	1	12	50/75	35	4
Ø4 - Ø4 - R0 - 16 - 50/75 - (T2-S2) - <0° - Z 4	4	4	0	0	2	2	16	50/75	35	4
Ø4 - Ø4 - R0 - 20 - 50/75 - (T3-S2) - <0° - Z 4	4	4	0	0	3	2	20	50/75	35	4



Ø4 CILINDRICHE A 2 DIAMETRI

PARAMETRI CONSIGLIATI

S	10000
F	2500/3000
PP	0,06/0,15

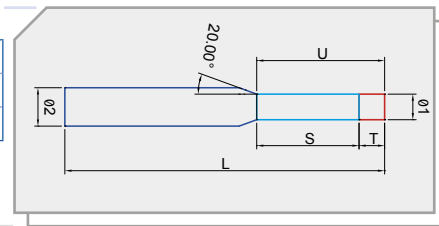

CODE: - Ø1-Ø2-R-U-L - (T-S) - < - z	DIAM.1	DIAM.2	0°-0,5°-1°-1,5°-2°...	RAGGIO	1XD-2XD-3XD SHARP	1XD-2XD-3XD Ø1/40	HELPFUL T+S	50/75 100/125	ELIX	FLUTES
	Ø 1	Ø 2	TAPER - (<°)	R	T	S	U	L	E 0°	Z
Ø4 - Ø6 - R0 - 16 - 75/100 - (T1-S3) - <0,5/1/1,5° - Z 4	4	6	0,5/1/1,5	0	1	3	16	75/100	35	4
Ø4 - Ø6 - R0 - 20 - 75/100 - (T1-S4) - <0,5/1/1,5° - Z 4	4	6	0,5/1/1,5	0	1	4	20	75/100	35	4
Ø4 - Ø6 - R0 - 24 - 75/100 - (T1-S5) - <0,5/1/1,5° - Z 4	4	6	0,5/1/1,5	0	1	5	24	75/100	35	4
Ø4 - Ø6 - R0 - 28 - 75/100 - (T1-S6) - <0,5/1/1,5° - Z 4	4	6	0,5/1/1,5	0	1	6	28	75/100	35	4
Ø4 - Ø6 - R0 - 32 - 75/100 - (T1-S7) - <0,5/1/1,5° - Z 4	4	6	0,5/1/1,5	0	1	7	32	75/100	35	4
Ø4 - Ø6 - R0 - 36 - 75/100 - (T1-S8) - <0,5/1/1,5° - Z 4	4	6	0,5/1/1,5	0	1	8	36	75/100	35	4
Ø4 - Ø6 - R0 - 40 - 75/100 - (T1-S9) - <0,5/1/1,5° - Z 4	4	6	0,5/1/1,5	0	1	9	40	75/100	35	4



Ø4 CILINDRICHE STANDARD

PARAMETRI CONSIGLIATI

S	10000
F	2500/3000
PP	0,06/0,15

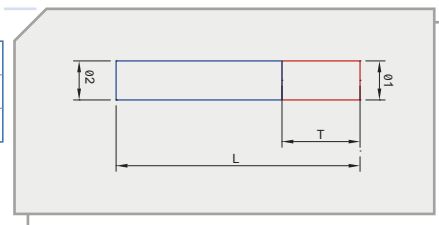

CODE: - Ø1-Ø2-R-U-L - (T-S) - < - z	DIAM.1	DIAM.2	0°-0,5°-1°-1,5°-2°...	RAGGIO	1XD-2XD-3XD SHARP	1XD-2XD-3XD Ø1/40	HELPFUL T+S	50/75 100/125	ELIX	FLUTES
	Ø 1	Ø 2	TAPER - (<°)	R	T	S	U	L	E 0°	Z
Ø4 - Ø4 - R0 - 4 - 50/75 - (T1-S0) - <0° - Z 4	4	4	0	0	1	0	4	50/75	35	4
Ø4 - Ø4 - R0 - 8 - 50/75 - (T2-S0) - <0° - Z 4	4	4	0	0	2	0	8	50/75	35	4
Ø4 - Ø4 - R0 - 12 - 50/75 - (T3-S0) - <0° - Z 4	4	4	0	0	3	0	12	50/75	35	4

TUTTI I NOSTRI UTENSILI SONO PERSONALIZZABILI IN OGNI PARAMENTRO Vai a pagina 36 per scoprire come chiedere i tuoi utensili personalizzati!

Ø4

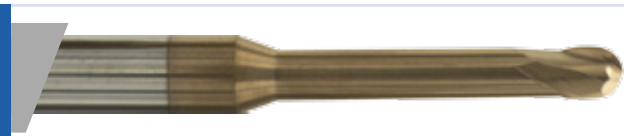

PARAMETRI CONSIGLIATI

S	11000
F	2200/2500
PP	0,06/0,15

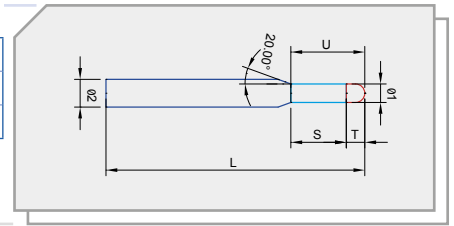

Ø4 SFERICA A 2 DIAMETRI

CODE: - Ø1-Ø2-R-U-L - (T-S) - <- z	DIAM.1	DIAM.2	0°-0,5°-1°-1,5°-2°...	RAGGIO	1XD-2XD-3XD SHARP	1XD-2XD-3XD Ø1/40	HELPPFUL T+S	50/75 100/125	ELIX	FLUTES
	Ø 1	Ø 2	TAPER - (<°)	R	T	S	U	L	E 0°	Z
Ø4 - Ø6 - R2 - 16 - 75/100 - (T1-S3) - <0° - Z 2	4	6	0	2	1	3	16	75/100	30	2
Ø4 - Ø6 - R2 - 20 - 75/100 - (T1-S4) - <0° - Z 2	4	6	0	2	1	4	20	75/100	30	2
Ø4 - Ø6 - R2 - 24 - 75/100 - (T1-S5) - <0° - Z 2	4	6	0	2	1	5	24	75/100	30	2
Ø4 - Ø6 - R2 - 28 - 75/100 - (T1-S6) - <0° - Z 2	4	6	0	2	1	6	28	75/100	30	2
Ø4 - Ø6 - R2 - 32 - 75/100 - (T1-S7) - <0° - Z 2	4	6	0	2	1	7	32	75/100	30	2
Ø4 - Ø6 - R2 - 36 - 75/100 - (T1-S8) - <0° - Z 2	4	6	0	2	1	8	36	75/100	30	2
Ø4 - Ø6 - R2 - 40 - 75/100 - (T1-S9) - <0° - Z 2	4	6	0	2	1	9	40	75/100	30	2



PARAMETRI CONSIGLIATI

S	11000
F	2200/2500
PP	0,06/0,15

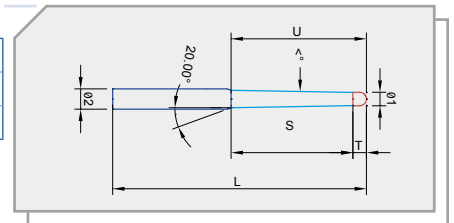

Ø4 SFERICHE CONICHE

CODE: - Ø1-Ø2-R-U-L - (T-S) - <- z	DIAM.1	DIAM.2	0°-0,5°-1°-1,5°-2°...	RAGGIO	1XD-2XD-3XD SHARP	1XD-2XD-3XD Ø1/40	HELPPFUL T+S	50/75 100/125	ELIX	FLUTES
	Ø 1	Ø 2	TAPER - (<°)	R	T	S	U	L	E 0°	Z
Ø4 - Ø6 - R2 - 16 - 75/100 - (T1-S3) - <0,5/1/1,5° - Z 4	4	6	0,5/1/1,5	2	1	3	16	75/100	35	4
Ø4 - Ø6 - R2 - 20 - 75/100 - (T1-S4) - <0,5/1/1,5° - Z 4	4	6	0,5/1/1,5	2	1	4	20	75/100	35	4
Ø4 - Ø6 - R2 - 24 - 75/100 - (T1-S5) - <0,5/1/1,5° - Z 4	4	6	0,5/1/1,5	2	1	5	24	75/100	35	4
Ø4 - Ø6 - R2 - 28 - 75/100 - (T1-S6) - <0,5/1/1,5° - Z 4	4	6	0,5/1/1,5	2	1	6	28	75/100	35	4
Ø4 - Ø6 - R2 - 32 - 75/100 - (T1-S7) - <0,5/1/1,5° - Z 4	4	6	0,5/1/1,5	2	1	7	32	75/100	35	4
Ø4 - Ø6 - R2 - 36 - 75/100 - (T1-S8) - <0,5/1/1,5° - Z 4	4	6	0,5/1/1,5	2	1	8	36	75/100	35	4
Ø4 - Ø6 - R2 - 40 - 75/100 - (T1-S9) - <0,5/1/1,5° - Z 4	4	6	0,5/1/1,5	2	1	9	40	75/100	35	4



PARAMETRI CONSIGLIATI

S	11000
F	2200/2500
PP	0,06/0,15

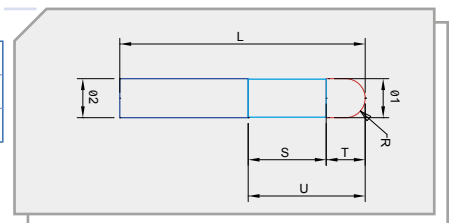

Ø4 SFERICHE STANDARD

CODE: - Ø1-Ø2-R-U-L - (T-S) - <- z	DIAM.1	DIAM.2	0°-0,5°-1°-1,5°-2°...	RAGGIO	1XD-2XD-3XD SHARP	1XD-2XD-3XD Ø1/40	HELPPFUL T+S	50/75 100/125	ELIX	FLUTES
	Ø 1	Ø 2	TAPER - (<°)	R	T	S	U	L	E 0°	Z
Ø4 - Ø4 - R2 - 8 - 50/75 - (T1-S1) - <0° - Z 2	4	4	0	2	1	1	8	50/75	30	2
Ø4 - Ø4 - R2 - 12 - 50/75 - (T1-S2) - <0° - Z 2	4	4	0	2	1	2	12	50/75	30	2
Ø4 - Ø4 - R2 - 16 - 50/75 - (T1-S3) - <0° - Z 2	4	4	0	2	1	3	16	50/75	30	2
Ø4 - Ø4 - R2 - 20 - 50/75 - (T1-S4) - <0° - Z 2	4	4	0	2	1	4	20	50/75	30	2

TUTTI I NOSTRI UTENSILI SONO PERSONALIZZABILI IN OGNI PARAMENTRO

Vai a pagina 36 per scoprire come chiedere i tuoi utensili personalizzati!



PARAMETRI CONSIGLIATI

S	10500
F	2500/3000
PP	0,06/0,15

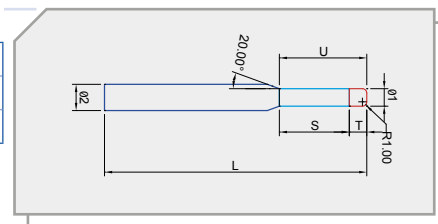

Ø4 TORICHE A 2 DIAMETRI

CODE: - Ø1-Ø2-R-U-L - (T-S) - < - z	DIAM.1	DIAM.2	0°-0.5°-1°-1.5°-2°...	RAGGIO	1XD-2XD-3XD SHARP	1XD-2XD-3XD Ø1/40	HELPFUL T+S	50/75 100/125	ELIX	FLUTES
	Ø 1	Ø 2	TAPER - (<°)	R	T	S	U	L	E 0°	Z
Ø4 - Ø6 - R0,5/1 - 16 - 50/75 (T1-S3) - <0° - Z 4	4	6	0	0,5/1	1	3	16	50/75	35	4
Ø4 - Ø6 - R0,5/1 - 20 - 50/75 (T1-S4) - <0° - Z 4	4	6	0	0,5/1	1	4	20	50/75	35	4
Ø4 - Ø6 - R0,5/1 - 24 - 50/75 (T1-S5) - <0° - Z 4	4	6	0	0,5/1	1	5	24	50/75	35	4
Ø4 - Ø6 - R0,5/1 - 28 - 75/100 (T1-S6) - <0° - Z 4	4	6	0	0,5/1	1	6	28	75/100	35	4
Ø4 - Ø6 - R0,5/1 - 32 - 75/100 (T1-S7) - <0° - Z 4	4	6	0	0,5/1	1	7	32	75/100	35	4
Ø4 - Ø6 - R0,5/1 - 36 - 75/100 (T1-S8) - <0° - Z 4	4	6	0	0,5/1	1	8	36	75/100	35	4
Ø4 - Ø6 - R0,5/1 - 40 - 75/100 (T1-S9) - <0° - Z 4	4	6	0	0,5/1	1	9	40	75/100	35	4

TUTTI I NOSTRI UTENSILI SONO PERSONALIZZABILI IN OGNI PARAMENTRO

Vai a pagina 36 per scoprirne come chiedere i tuoi utensili personalizzati!



PARAMETRI CONSIGLIATI

S	10500
F	2500/3000
PP	0,06/0,15

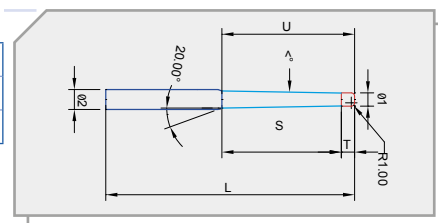

Ø4 TORICHE CONICHE

CODE: - Ø1-Ø2-R-U-L - (T-S) - < - z	DIAM.1	DIAM.2	0°-0.5°-1°-1.5°-2°...	RAGGIO	1XD-2XD-3XD SHARP	1XD-2XD-3XD Ø1/40	HELPFUL T+S	50/75 100/125	ELIX	FLUTES
	Ø 1	Ø 2	TAPER - (<°)	R	T	S	U	L	E 0°	Z
Ø4 - Ø6 - R0,5/1 - 16 - 75/100 (T1-S3) - <0,5/1/1,5° - Z 4	4	6	0,5/1/1,5	0,5/1	1	3	16	75/100	35	4
Ø4 - Ø6 - R0,5/1 - 20 - 75/100 (T1-S4) - <0,5/1/1,5° - Z 4	4	6	0,5/1/1,5	0,5/1	1	4	20	75/100	35	4
Ø4 - Ø6 - R0,5/1 - 24 - 75/100 (T1-S5) - <0,5/1/1,5° - Z 4	4	6	0,5/1/1,5	0,5/1	1	5	24	75/100	35	4
Ø4 - Ø6 - R0,5/1 - 28 - 75/100 (T1-S6) - <0,5/1/1,5° - Z 4	4	6	0,5/1/1,5	0,5/1	1	6	28	75/100	35	4
Ø4 - Ø6 - R0,5/1 - 32 - 75/100 (T1-S7) - <0,5/1/1,5° - Z 4	4	6	0,5/1/1,5	0,5/1	1	7	32	75/100	35	4
Ø4 - Ø6 - R0,5/1 - 36 - 75/100 (T1-S8) - <0,5/1/1,5° - Z 4	4	6	0,5/1/1,5	0,5/1	1	8	36	75/100	35	4
Ø4 - Ø6 - R0,5/1 - 40 - 75/100 (T1-S9) - <0,5/1/1,5° - Z 4	4	6	0,5/1/1,5	0,5/1	1	9	40	75/100	35	4

TUTTI I NOSTRI UTENSILI SONO PERSONALIZZABILI IN OGNI PARAMENTRO

Vai a pagina 36 per scoprirne come chiedere i tuoi utensili personalizzati!

Ø 4



Ø4 TORICHE STANDARD

PARAMETRI CONSIGLIATI

S	10500
F	2500/3000
PP	0,06/0,15

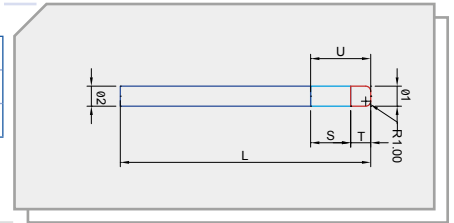

CODE: - Ø1-Ø2-R-U-L - (T-S) - < - z	DIAM.1	DIAM.2	0°-0,5°-1°-1,5°-2°...	RAGGIO	1XD-2XD-3XD SHARP	1XD-2XD-3XD Ø1/40	HELPFUL T+S	50/75 100/125	ELIX	FLUTES
	Ø 1	Ø 2	TAPER - (<°)	R	T	S	U	L	E 0°	Z
Ø4 - Ø4 - R0,5/1 - 8 - 50/75 (T1-S1) - <0° - Z 4	4	4	0	0,5/1	1	1	8	50/75	35	4
Ø4 - Ø4 - R0,5/1 - 12 - 50/75 (T1-S2) - <0° - Z 4	4	4	0	0,5/1	1	2	12	50/75	35	4
Ø4 - Ø4 - R0,5/1 - 16 - 50/75 (T1-S3) - <0° - Z 4	4	4	0	0,5/1	1	3	16	50/75	35	4
Ø4 - Ø4 - R0,5/1 - 20 - 50/75 (T1-S4) - <0° - Z 4	4	4	0	0,5/1	1	4	20	50/75	35	4

TUTTI I NOSTRI UTENSILI SONO PERSONALIZZABILI IN OGNI PARAMENTRO

Vai a pagina 36 per scoprirne come chiedere i tuoi utensili personalizzati!



Ø4 CILINDRICHE CONICHE

PARAMETRI CONSIGLIATI

S	10000
F	2500/3000
PP	0,06/0,15

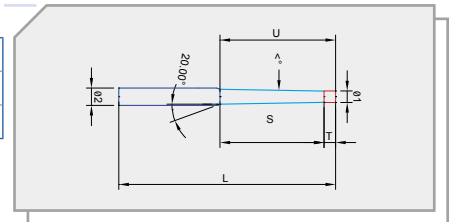

CODE: - Ø1-Ø2-R-U-L - (T-S) - < - z	DIAM.1	DIAM.2	0°-0,5°-1°-1,5°-2°...	RAGGIO	1XD-2XD-3XD SHARP	1XD-2XD-3XD Ø1/40	HELPFUL T+S	50/75 100/125	ELIX	FLUTES
	Ø 1	Ø 2	TAPER - (<°)	R	T	S	U	L	E 0°	Z
Ø4 - Ø6 - R0 - 16 - 75/100 (T1-S3) - <0,5/1/1,5° - Z 4	4	6	0,5/1/1,5	0	1	3	16	75/100	35	4
Ø4 - Ø6 - R0 - 20 - 75/100 (T1-S4) - <0,5/1/1,5° - Z 4	4	6	0,5/1/1,5	0	1	4	20	75/100	35	4
Ø4 - Ø6 - R0 - 24 - 75/100 (T1-S5) - <0,5/1/1,5° - Z 4	4	6	0,5/1/1,5	0	1	5	24	75/100	35	4
Ø4 - Ø6 - R0 - 28 - 75/100 (T1-S6) - <0,5/1/1,5° - Z 4	4	6	0,5/1/1,5	0	1	6	28	75/100	35	4
Ø4 - Ø6 - R0 - 32 - 75/100 (T1-S7) - <0,5/1/1,5° - Z 4	4	6	0,5/1/1,5	0	1	7	32	75/100	35	4
Ø4 - Ø6 - R0 - 36 - 75/100 (T1-S8) - <0,5/1/1,5° - Z 4	4	6	0,5/1/1,5	0	1	8	36	75/100	35	4
Ø4 - Ø6 - R0 - 40 - 75/100 (T1-S9) - <0,5/1/1,5° - Z 4	4	6	0,5/1/1,5	0	1	9	40	75/100	35	4

TUTTI I NOSTRI UTENSILI SONO PERSONALIZZABILI IN OGNI PARAMENTRO

Vai a pagina 36 per scoprirne come chiedere i tuoi utensili personalizzati!

DIAMETRO > 6 <



Ø6 CILINDRICHE STANDARD

PARAMETRI CONSIGLIATI

S	9000
F	2500/3500
PP	0,07/0,18

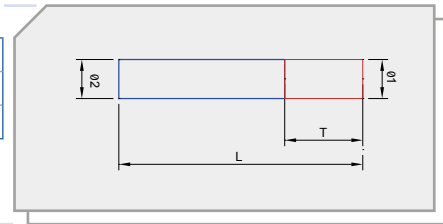

CODE: - Ø1-Ø2-R-U-L - (T-S) - <- z	DIAM.1	DIAM.2	0°-0,5°-1°-1,5°-2°...	RAGGIO	1XD-2XD-3XD SHARP	1XD-2XD-3XD Ø1/40	HELPFUL T+S	50/75 100/125	ELIX	FLUTES
	Ø 1	Ø 2	TAPER - (<°)	R	T	S	U	L	E 0°	Z
Ø6 - Ø6 - R0 - 6 - 50/75/100 (T1-S0) - <0° - Z 4	6	6	0	0	1	0	6	50/75/100	35	4
Ø6 - Ø6 - R0 - 12 - 50/75/100 (T2-S0) - <0° - Z 4	6	6	0	0	2	0	12	50/75/100	35	4
Ø6 - Ø6 - R0 - 18 - 50/75/100 (T3-S0) - <0° - Z 4	6	6	0	0	3	0	18	50/75/100	35	4

TUTTI I NOSTRI UTENSILI SONO PERSONALIZZABILI IN OGNI PARAMENTRO Vai a pagina 36 per scoprirne come chiedere i tuoi utensili personalizzati!



Ø6 CILINDRICHE SCARICATE

PARAMETRI CONSIGLIATI

S	9000
F	2500/3500
PP	0,07/0,18

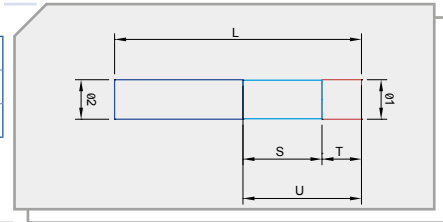

CODE: - Ø1-Ø2-R-U-L - (T-S) - <- z	DIAM.1	DIAM.2	0°-0,5°-1°-1,5°-2°...	RAGGIO	1XD-2XD-3XD SHARP	1XD-2XD-3XD Ø1/40	HELPFUL T+S	50/75 100/125	ELIX	FLUTES
	Ø 1	Ø 2	TAPER - (<°)	R	T	S	U	L	E 0°	Z
Ø6 - Ø6 - R0 - 12 - 50/75/100 (T1-S1) - <0° - Z 4	6	6	0	0	1	1	12	50/75/100	35°	4
Ø6 - Ø6 - R0 - 18 - 75/100 (T1-S2) - <0° - Z 4	6	6	0	0	1	2	18	75/100	35	4
Ø6 - Ø6 - R0 - 24 - 75/100 (T1-S3) - <0° - Z 4	6	6	0	0	1	3	24	75/100	35	4
Ø6 - Ø6 - R0 - 30 - 75/100 (T1-S4) - <0° - Z 4	6	6	0	0	1	4	30	75/100	35	4
Ø6 - Ø6 - R0 - 18 - 50/75 (T2-S1) - <0° - Z 4	6	6	0	0	2	1	18	50/75	35	4
Ø6 - Ø6 - R0 - 24 - 50/75 (T2-S2) - <0° - Z 4	6	6	0	0	2	2	24	50/75	35	4
Ø6 - Ø6 - R0 - 30 - 50/75 (T3-S2) - <0° - Z 4	6	6	0	0	3	2	30	50/75	35	4



Ø6 SFERICHE STANDARD

PARAMETRI CONSIGLIATI

S	9500
F	2500/3000
PP	0,07/0,18

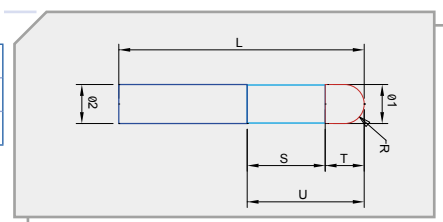

CODE: - Ø1-Ø2-R-U-L - (T-S) - <- z	DIAM.1	DIAM.2	0°-0,5°-1°-1,5°-2°...	RAGGIO	1XD-2XD-3XD SHARP	1XD-2XD-3XD Ø1/40	HELPFUL T+S	50/75 100/125	ELIX	FLUTES
	Ø 1	Ø 2	TAPER - (<°)	R	T	S	U	L	E 0°	Z
Ø6 - Ø6 - R3 - 12 - 50 (T1-S1) - <0° - Z 2	6	6	0	3	1	1	12	50	30	2
Ø6 - Ø6 - R3 - 18 - 75 (T1-S2) - <0° - Z 2	6	6	0	3	1	2	18	75	30	2
Ø6 - Ø6 - R3 - 24 - 75/100 (T1-S3) - <0° - Z 2	6	6	0	3	1	3	24	75/100	30	2
Ø6 - Ø6 - R3 - 30 - 75/100 (T1-S4) - <0° - Z 2	6	6	0	3	1	4	30	75/100	30	2

TUTTI I NOSTRI UTENSILI SONO PERSONALIZZABILI IN OGNI PARAMENTRO Vai a pagina 36 per scoprirne come chiedere i tuoi utensili personalizzati!

Ø6



PARAMETRI CONSIGLIATI

S	9000
F	2500/3500
PP	0,07/0,18

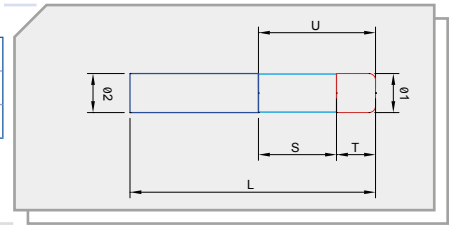

Ø6 TORICHE STANDARD

CODE: - Ø1-Ø2-R-U-L - (T-S) - <- z	DIAM.1	DIAM.2	0°-0,5°-1°-1,5°-2°...	RAGGIO	1XD-2XD-3XD SHARP	1XD-2XD-3XD Ø1/40	HELPFUL T+S	50/75 100/125	ELIX	FLUTES
	Ø 1	Ø 2	TAPER - (<°)	R	T	S	U	L	E 0°	Z
Ø6 - Ø6 - R0,50/1/2 - 12 - 50/75/100 (T1-S1) - <0° - Z 4	6	6	0	0,50/1/2	1	1	12	50/75/100	35	4
Ø6 - Ø6 - R0,50/1/2 - 18 - 75/100 (T1-S2) - <0° - Z 4	6	6	0	0,5/1/2	1	2	18	75/100	35	4
Ø6 - Ø6 - R0,50/1/2 - 24 - 75/100 (T1-S3) - <0° - Z 4	6	6	0	0,5/1/2	1	3	24	75/100	35	4
Ø6 - Ø6 - R0,50/1/2 - 30 - 75/100 (T1-S4) - <0° - Z 4	6	6	0	0,5/1/2	1	4	30	75/100	35	4

TUTTI I NOSTRI UTENSILI SONO PERSONALIZZABILI IN OGNI PARAMENTRO

Vai a pagina 36 per scoprirne come chiedere i tuoi utensili personalizzati!



PARAMETRI CONSIGLIATI

S	9000
F	2500/3500
PP	0,07/0,18

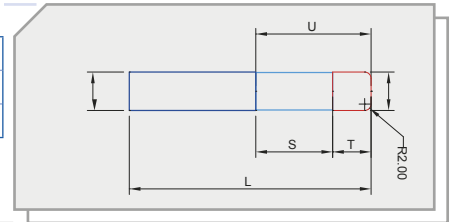

Ø6 TORICHE 5 TAGLIENTI

CODE: - Ø1-Ø2-R-U-L - (T-S) - <- z	DIAM.1	DIAM.2	0°-0,5°-1°-1,5°-2°...	RAGGIO	1XD-2XD-3XD SHARP	1XD-2XD-3XD Ø1/40	HELPFUL T+S	50/75 100/125	ELIX	FLUTES
	Ø 1	Ø 2	TAPER - (<°)	R	T	S	U	L	E 0°	Z
Ø6 - Ø6 - R0,50/1/2 - 12 - 50/75 - (T1-S1) - <0° - Z 5	6	6	0	0,50/1/2	1	1	12	50/75	35	5
Ø6 - Ø6 - R0,50/1/2 - 18 - 50/75 - (T1-S2) - <0° - Z 5	6	6	0	0,5/1/2	1	2	18	50/75	35	5
Ø6 - Ø6 - R0,50/1/2 - 24 - 50/75 - (T1-S3) - <0° - Z 5	6	6	0	0,5/1/2	1	3	24	50/75	35	5
Ø6 - Ø6 - R0,50/1/2 - 30 - 50/75 - (T1-S4) - <0° - Z 5	6	6	0	0,5/1/2	1	4	30	50/75	35	5

TUTTI I NOSTRI UTENSILI SONO PERSONALIZZABILI IN OGNI PARAMENTRO

Vai a pagina 36 per scoprirne come chiedere i tuoi utensili personalizzati!

DIAMETRO > 8 <



PARAMETRI CONSIGLIATI

S	8000
F	2500/3500
PP	0,1/0,2

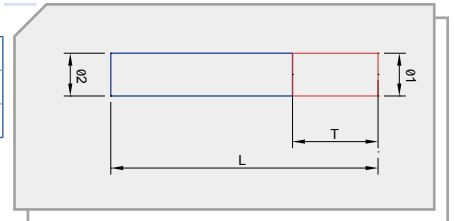

Ø8 CILINDRICHE STANDARD

CODE: - Ø1-Ø2-R-U-L - (T-S) - <- z	DIAM.1	DIAM.2	0°-0,5°-1°-1,5°-2°...	RAGGIO	1XD-2XD-3XD SHARP	1XD-2XD-3XD Ø1/40	HELPFUL T+S	50/75 100/125	ELIX	FLUTES
	Ø 1	Ø 2	TAPER - (<°)	R	T	S	U	L	E 0°	Z
Ø8 - Ø8 - R0 - 8 - 50/75/100 - (T1-S0) - <0° - Z 4	8	8	0	0	1	0	8	50/75/100	35	4
Ø8 - Ø8 - R0 - 16 - 50/75/100 - (T2-S0) - <0° - Z 4	8	8	0	0	2	0	16	50/75/100	35	4
Ø8 - Ø8 - R0 - 24 - 50/75/100 - (T3-S0) - <0° - Z 4	8	8	0	0	3	0	24	50/75/100	35	4



Ø8 CILINDRICHE SCARICATE

PARAMETRI CONSIGLIATI

S	8000
F	2500/3500
PP	0,1/0,2

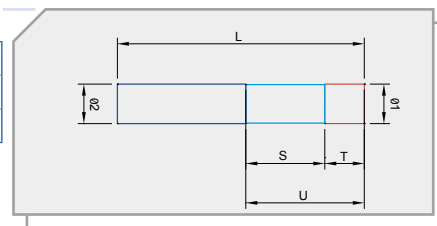

CODE: - Ø1-Ø2-R-U-L - (T-S) - <° - Z	DIAM.1	DIAM.2	0°-0,5°-1°-1,5°-2°...	RAGGIO	1XD-2XD-3XD SHARP	1XD-2XD-3XD Ø1/40	HELPFUL T+S	50/75 100/125	ELIX	FLUTES
	Ø 1	Ø 2	TAPER - (<°)	R	T	S	U	L	E 0°	Z
Ø8 - Ø8 - R0 - 16 - 50/75/100 (T1-S1) - <0° - Z 4	8	8	0	0	1	1	16	50/75/100	35°	4
Ø8 - Ø8 - R0 - 24 - 75/100 (T1-S2) - <0° - Z 4	8	8	0	0	1	2	24	75/100	35	4
Ø8 - Ø8 - R0 - 32 - 75/100 (T1-S3) - <0° - Z 4	8	8	0	0	1	3	32	75/100	35	4
Ø8 - Ø8 - R0 - 40 - 75/100 (T1-S4) - <0° - Z 4	8	8	0	0	1	4	40	75/100	35	4
Ø8 - Ø8 - R0 - 24 - 75/100 (T2-S1) - <0° - Z 4	8	8	0	0	2	1	24	75/100	35	4
Ø8 - Ø8 - R0 - 32 - 75/100 (T2-S2) - <0° - Z 4	8	8	0	0	2	2	32	75/100	35	4
Ø8 - Ø8 - R0 - 40 - 75/100 (T3-S2) - <0° - Z 4	8	8	0	0	3	2	40	75/100	35	4



Ø8 SFERICHE STANDARD

PARAMETRI CONSIGLIATI

S	9000
F	2500/3500
PP	0,1/0,2

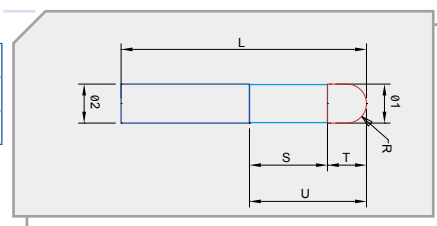

CODE: - Ø1-Ø2-R-U-L - (T-S) - <° - Z	DIAM.1	DIAM.2	0°-0,5°-1°-1,5°-2°...	RAGGIO	1XD-2XD-3XD SHARP	1XD-2XD-3XD Ø1/40	HELPFUL T+S	50/75 100/125	ELIX	FLUTES
	Ø 1	Ø 2	TAPER - (<°)	R	T	S	U	L	E 0°	Z
Ø8 - Ø8 - R4 - 16 - 50 - (T1-S1) - <0° - Z 2	8	8	0	4	1	1	16	50	30	2
Ø8 - Ø8 - R4 - 24 - 75 - (T1-S2) - <0° - Z 2	8	8	0	4	1	2	24	75	30	2
Ø8 - Ø8 - R4 - 32 - 75/100 - (T1-S3) - <0° - Z 2	8	8	0	4	1	3	32	75/100	30	2
Ø8 - Ø8 - R4 - 40 - 75/100 - (T1-S4) - <0° - Z 2	8	8	0	4	1	4	40	75/100	30	2



Ø8 TORICHE STANDARD

PARAMETRI CONSIGLIATI

S	8500
F	2500/4000
PP	0,1/0,2

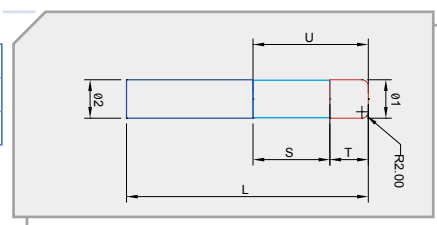

CODE: - Ø1-Ø2-R-U-L - (T-S) - <° - Z	DIAM.1	DIAM.2	0°-0,5°-1°-1,5°-2°...	RAGGIO	1XD-2XD-3XD SHARP	1XD-2XD-3XD Ø1/40	HELPFUL T+S	50/75 100/125	ELIX	FLUTES
	Ø 1	Ø 2	TAPER - (<°)	R	T	S	U	L	E 0°	Z
Ø8 - Ø8 - R0,50/1/2 - 16 - 50/75/100 - (T1-S1) - <0° - Z 4	8	8	0	0,50/1/2	1	1	16	50/75/100	35	4
Ø8 - Ø8 - R0,50/1/2 - 24 - 75/100 - (T1-S2) - <0° - Z 4	8	8	0	0,5/1/2	1	2	24	75/100	35	4
Ø8 - Ø8 - R0,50/1/2 - 32 - 75/100 - (T1-S3) - <0° - Z 4	8	8	0	0,5/1/2	1	3	32	75/100	35	4
Ø8 - Ø8 - R0,50/1/2 - 40 - 75/100 - (T1-S4) - <0° - Z 4	8	8	0	0,5/1/2	1	4	40	75/100	35	4

TUTTI I NOSTRI UTENSILI SONO PERSONALIZZABILI IN OGNI PARAMENTRO

Vai a pagina 36 per scoprire come chiedere i tuoi utensili personalizzati!

Ø 10



Ø8TORICHE 5 TAGLIANTI

PARAMETRI
CONSIGLIATI

S	8500
F	2500/4000
PP	0,1/0,2

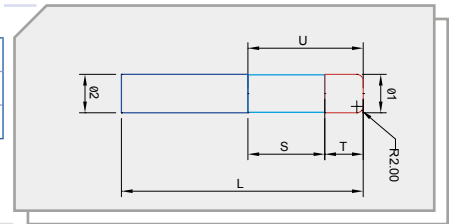

CODE: - Ø1-Ø2-R-U-L - (T-S) - < - Z	DIAM.1	DIAM.2	0°-0,5°-1°- 1,5°-2°...	RAGGIO	1XD-2XD- 3XD SHARP	1XD- 2XD-3XD Ø1/40	HELPFUL T+S	50/75 100/125	ELIX	FLUTES
	Ø 1	Ø 2	TAPER - (<°)	R	T	S	U	L	E 0°	Z
Ø10 - Ø10 - R0,50/1/2 - 20 - 50/75/100 - (T1-S1) - <0° - Z	10	10	0	0,50/1/2	1	1	20	50/75/100	35	4
Ø10 - Ø10 - R0,50/1/2 - 30 - 75/100 - (T1-S2) - <0° - Z	10	10	0	0,5/1/2	1	2	30	75/100	35	4
Ø10 - Ø10 - R0,50/1/2 - 40 - 75/100 - (T1-S3) - <0° - Z	10	10	0	0,5/1/2	1	3	40	75/100	35	4
Ø10 - Ø10 - R0,50/1/2 - 50 - 100 - (T1-S4) - <0° - Z	10	10	0	0,5/1/2	1	4	50	100	35	4

TUTTI I NOSTRI UTENSILI SONO
PERSONALIZZABILI IN OGNI PARAMENTRO

Vai a pagina 36 per scoprirne come chiedere i tuoi utensili personalizzati!

DIAMETRO > 10 <



Ø10 CILINDRICHE STANDARD

PARAMETRI
CONSIGLIATI

S	70900
F	2500/3500
PP	0,1/0,2

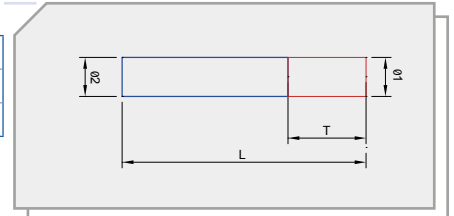

CODE: - Ø1-Ø2-R-U-L - (T-S) - < - Z	DIAM.1	DIAM.2	0°-0,5°-1°- 1,5°-2°...	RAGGIO	1XD-2XD- 3XD SHARP	1XD- 2XD-3XD Ø1/40	HELPFUL T+S	50/75 100/125	ELIX	FLUTES
	Ø 1	Ø 2	TAPER - (<°)	R	T	S	U	L	E 0°	Z
Ø10 - Ø10 - R0 - 10 - 50/75/100 - (T1-S0) - <0° - Z 4	10	10	0	0	1	0	10	50/75/100	35	4
Ø10 - Ø10 - R0 - 20 - 50/75/100 - (T2-S0) - <0° - Z 4	10	10	0	0	2	0	20	50/75/100	35	4
Ø10 - Ø10 - R0 - 30 - 75/100 - (T3-S0) - <0° - Z 4	10	10	0	0	3	0	30	75/100	35	4

TUTTI I NOSTRI UTENSILI SONO
PERSONALIZZABILI IN OGNI PARAMENTRO

Vai a pagina 36 per scoprirne come chiedere i tuoi utensili personalizzati!



PARAMETRI CONSIGLIATI

S	70900
F	2500/3500
PP	0,1/0,2

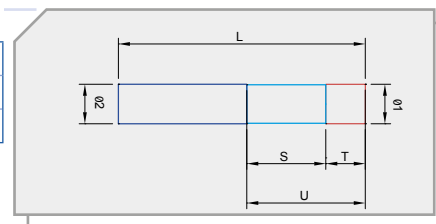

Ø10 CILINDRICHE SCARICATE

CODE: - Ø1-Ø2-R-U-L - (T-S) - < - Z	DIAM.1	DIAM.2	0°-0,5°-1°-1,5°-2°...	RAGGIO	1XD-2XD-3XD SHARP	1XD-2XD-3XD Ø1/40	HELPFUL T+S	50/75 100/125	ELIX	FLUTES
	Ø 1	Ø 2	TAPER - (<°)	R	T	S	U	L	E 0°	Z
Ø10 - Ø10 - R0 - 20 - 50/75/100 (T1-S1) - <0° - Z 4	10	10	0	0	1	1	20	50/75/100	35°	4
Ø10 - Ø10 - R0 - 30 - 75/100 (T1-S2) - <0° - Z 4	10	10	0	0	1	2	30	75/100	35	4
Ø10 - Ø10 - R0 - 40 - 75/100 (T1-S3) - <0° - Z 4	10	10	0	0	1	3	40	75/100	35	4
Ø10 - Ø10 - R0 - 50 - 75/100 (T1-S4) - <0° - Z 4	10	10	0	0	1	4	50	75/100	35	4
Ø10 - Ø10 - R0 - 30 - 75/100 (T2-S1) - <0° - Z 4	10	10	0	0	2	1	30	75/100	35	4
Ø10 - Ø10 - R0 - 40 - 75/100 (T2-S2) - <0° - Z 4	10	10	0	0	2	2	40	75/100	35	4
Ø10 - Ø10 - R0 - 50 - 75/100 (T3-S2) - <0° - Z 4	10	10	0	0	3	2	50	75/100	35	4



PARAMETRI CONSIGLIATI

S	7500
F	2500/3500
PP	0,15/0,25

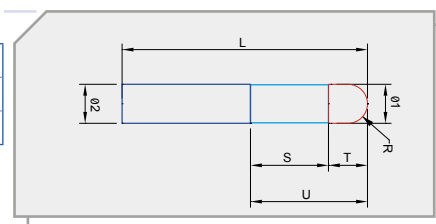

Ø10 SFERICHE STANDARD

CODE: - Ø1-Ø2-R-U-L - (T-S) - < - Z	DIAM.1	DIAM.2	0°-0,5°-1°-1,5°-2°...	RAGGIO	1XD-2XD-3XD SHARP	1XD-2XD-3XD Ø1/40	HELPFUL T+S	50/75 100/125	ELIX	FLUTES
	Ø 1	Ø 2	TAPER - (<°)	R	T	S	U	L	E 0°	Z
Ø10 - Ø10 - R5 - 20 - 50 - (T1-S1) - <0° - Z 2	10	10	0	5	1	1	20	50	30	2
Ø10 - Ø10 - R5 - 30 - 75 - (T1-S2) - <0° - Z 2	10	10	0	5	1	2	30	75	30	2
Ø10 - Ø10 - R5 - 40 - 75/100 - (T1-S3) - <0° - Z 2	10	10	0	5	1	3	40	75/100	30	2
Ø10 - Ø10 - R5 - 50 - 100 - (T1-S4) - <0° - Z 2	10	10	0	5	1	4	50	100	30	2



PARAMETRI CONSIGLIATI

S	7500
F	2500/4000
PP	0,15/0,25

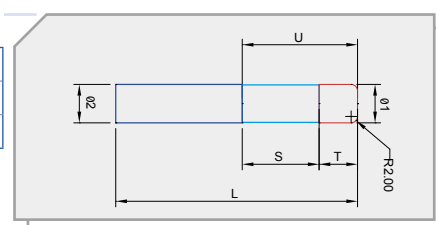

Ø10 TORICHE STANDARD

CODE: - Ø1-Ø2-R-U-L - (T-S) - < - Z	DIAM.1	DIAM.2	0°-0,5°-1°-1,5°-2°...	RAGGIO	1XD-2XD-3XD SHARP	1XD-2XD-3XD Ø1/40	HELPFUL T+S	50/75 100/125	ELIX	FLUTES
	Ø 1	Ø 2	TAPER - (<°)	R	T	S	U	L	E 0°	Z
Ø10 - Ø10 - R0,50/1/2 - 20 - 50/75/100 - (T1-S1) - <0° - Z 4	10	10	0	0,50/1/2	1	1	20	50/75/100	35	4
Ø10 - Ø10 - R0,50/1/2 - 30 - 75/100 - (T1-S2) - <0° - Z 4	10	10	0	0,5/1/2	1	2	30	75/100	35	4
Ø10 - Ø10 - R0,50/1/2 - 40 - 75/100 - (T1-S3) - <0° - Z 4	10	10	0	0,5/1/2	1	3	40	75/100	35	4
Ø10 - Ø10 - R0,50/1/2 - 50 - 100 - (T1-S4) - <0° - Z 4	10	10	0	0,5/1/2	1	4	50	100	35	4

TUTTI I NOSTRI UTENSILI SONO PERSONALIZZABILI IN OGNI PARAMENTRO

Vai a pagina 36 per scoprirne come chiedere i tuoi utensili personalizzati!

Ø 12



Ø10 TORICHE 5 TAGLIENTI

PARAMETRI CONSIGLIATI

S	7500
F	2500/4000
PP	0,15/0,25

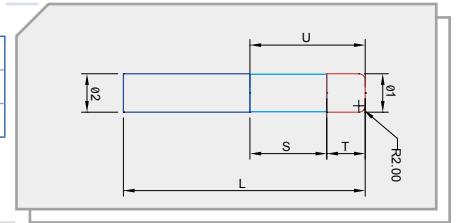

CODE: - Ø1-Ø2-R-U-L - (T-S) - < - z	DIAM.1	DIAM.2	0°-0,5°-1°-1,5°-2°...	RAGGIO	1XD-2XD-3XD SHARP	1XD-2XD-3XD Ø1/40	HELPFUL T+S	50/75 100/125	ELIX	FLUTES
	Ø 1	Ø 2	TAPER - (<°)	R	T	S	U	L	E 0°	Z
Ø10 - Ø10 - R0,50/1/2 - 20 - 50/75/100 - (T1-S1) - <0° - Z	10	10	0	0,50/1/2	1	1	20	50/75/100	35	4
Ø10 - Ø10 - R0,50/1/2 - 30 - 75/100 - (T1-S2) - <0° - Z	10	10	0	0,5/1/2	1	2	30	75/100	35	4
Ø10 - Ø10 - R0,50/1/2 - 40 - 75/100 - (T1-S3) - <0° - Z	10	10	0	0,5/1/2	1	3	40	75/100	35	4
Ø10 - Ø10 - R0,50/1/2 - 50 - 100 - (T1-S4) - <0° - Z	10	10	0	0,5/1/2	1	4	50	100	35	4

TUTTI I NOSTRI UTENSILI SONO PERSONALIZZABILI IN OGNI PARAMENTRO

Vai a pagina 36 per scoprirne come chiedere i tuoi utensili personalizzati!

DIAMETRO > 12 <



Ø12 CILINDRICHE SCARICATE

PARAMETRI CONSIGLIATI

S	6000
F	2500/3500
PP	0,15/0,2

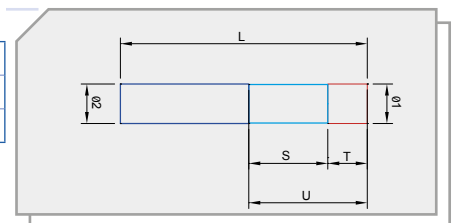

CODE: - Ø1-Ø2-R-U-L - (T-S) - < - z	DIAM.1	DIAM.2	0°-0,5°-1°-1,5°-2°...	RAGGIO	1XD-2XD-3XD SHARP	1XD-2XD-3XD Ø1/40	HELPFUL T+S	50/75 100/125	ELIX	FLUTES
	Ø 1	Ø 2	TAPER - (<°)	R	T	S	U	L	E 0°	Z
Ø12 - Ø12 - R0 - 24 - 50/75/100 (T1-S1) - <0° - Z 4	12	12	0	0	1	1	24	50/75/100	35°	4
Ø12 - Ø12 - R0 - 36 - 75/100 (T1-S2) - <0° - Z 4	12	12	0	0	1	2	36	75/100	35	4
Ø12 - Ø12 - R0 - 48 - 75/100 (T1-S3) - <0° - Z 4	12	12	0	0	1	3	48	75/100	35	4
Ø12 - Ø12 - R0 - 60 - 100 (T1-S4) - <0° - Z 4	12	12	0	0	1	4	60	100	35	4
Ø12 - Ø12 - R0 - 36 - 75/100 (T2-S1) - <0° - Z 4	12	12	0	0	2	1	36	75/100	35	4
Ø12 - Ø12 - R0 - 48 - 75/100 (T2-S2) - <0° - Z 4	12	12	0	0	2	2	48	75/100	35	4
Ø12 - Ø12 - R0 - 60 - 100 (T3-S2) - <0° - Z 4	12	12	0	0	3	2	60	100	35	4

TUTTI I NOSTRI UTENSILI SONO PERSONALIZZABILI IN OGNI PARAMENTRO

Vai a pagina 36 per scoprirne come chiedere i tuoi utensili personalizzati!



Ø12 SFERICHE STANDARD

PARAMETRI CONSIGLIATI

S	7500
F	2500/3500
PP	0,15/0,25

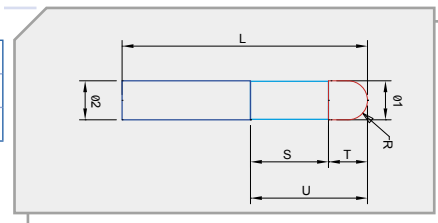

CODE: - Ø1-Ø2-R-U-L - (T-S) - < - z	DIAM.1	DIAM.2	0°-0,5°-1°-1,5°-2°...	RAGGIO	1XD-2XD-3XD SHARP	1XD-2XD-3XD Ø1/40	HELPFUL T+S	50/75 100/125	ELIX	FLUTES
	Ø 1	Ø 2	TAPER - (<°)	R	T	S	U	L	E 0°	Z
Ø12 - Ø12 - R6 - 24 - 50 -- (T1-S1) - <0° - Z 2	12	12	0	6	1	1	24	50	30	2
Ø12 - Ø12 - R6 - 36 - 75 -- (T1-S2) - <0° - Z 2	12	12	0	6	1	2	36	75	30	2
Ø12 - Ø12 - R6 - 48 - 75/100 -- (T1-S3) - <0° - Z 2	12	12	0	6	1	3	48	75/100	30	2
Ø12 - Ø12 - R6 - 60 - 100 -- (T1-S4) - <0° - Z 2	12	12	0	6	1	4	60	100	30	2

TUTTI I NOSTRI UTENSILI SONO PERSONALIZZABILI IN OGNI PARAMENTRO

Vai a pagina 36 per scopirne come chiedere i tuoi utensili personalizzati!



Ø12 TORICHE STANDARD

PARAMETRI CONSIGLIATI

S	6500
F	2500/4000
PP	0,15/0,25

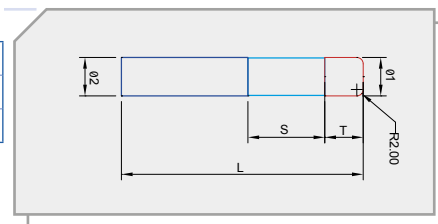

CODE: - Ø1-Ø2-R-U-L - (T-S) - < - z	DIAM.1	DIAM.2	0°-0,5°-1°-1,5°-2°...	RAGGIO	1XD-2XD-3XD SHARP	1XD-2XD-3XD Ø1/40	HELPFUL T+S	50/75 100/125	ELIX	FLUTES
	Ø 1	Ø 2	TAPER - (<°)	R	T	S	U	L	E 0°	Z
Ø12 - Ø12 - R0,50/1/2 - 24 - 50/75/100 (T1-S1) - <0° - Z 4	12	12	0	0,50/1/2	1	1	24	50/75/100	35	4
Ø12 - Ø12 - R0,50/1/2 - 36 - 75/100 (T1-S2) - <0° - Z 4	12	12	0	0,5/1/2	1	2	36	75/100	35	4
Ø12 - Ø12 - R0,50/1/2 - 48 - 75/100 (T1-S3) - <0° - Z 4	12	12	0	0,5/1/2	1	3	48	75/100	35	4
Ø12 - Ø12 - R0,50/1/2 - 60 - 100 (T1-S4) - <0° - Z 4	12	12	0	0,5/1/2	1	4	60	100	35	4

TUTTI I NOSTRI UTENSILI SONO PERSONALIZZABILI IN OGNI PARAMENTRO

Vai a pagina 36 per scopirne come chiedere i tuoi utensili personalizzati!



Ø12 CILINDRICHE STANDARD

PARAMETRI CONSIGLIATI

S	6000
F	2500/3500
PP	0,15/0,2

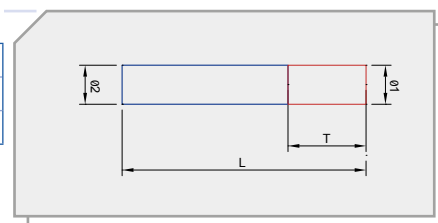

CODE: - Ø1-Ø2-R-U-L - (T-S) - < - z	DIAM.1	DIAM.2	0°-0,5°-1°-1,5°-2°...	RAGGIO	1XD-2XD-3XD SHARP	1XD-2XD-3XD Ø1/40	HELPFUL T+S	50/75 100/125	ELIX	FLUTES
	Ø 1	Ø 2	TAPER - (<°)	R	T	S	U	L	E 0°	Z
Ø12 - Ø12 - R0 - 12 - 50/75/100 -- (T1-S0) - <0° - Z 4	12	12	0	0	1	0	12	50/75/100	35	4
Ø12 - Ø12 - R0 - 24 - 50/75/100 -- (T2-S0) - <0° - Z 4	12	12	0	0	2	0	24	50/75/100	35	4
Ø12 - Ø12 - R0 - 36 - 75/100 -- (T3-S0) - <0° - Z	12	12	0	0	3	0	36	75/100		

TUTTI I NOSTRI UTENSILI SONO PERSONALIZZABILI IN OGNI PARAMENTRO

Vai a pagina 36 per scopirne come chiedere i tuoi utensili personalizzati!



PARAMETRI CONSIGLIATI

S	6500
F	2500/4000
PP	0,15/0,25

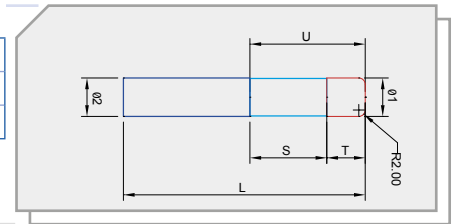

Ø12 TORICHE 5 TAGLIENTI

CODE: - Ø1-Ø2-R-U-L - (T-S) - <- z	DIAM.1	DIAM.2	0°-0,5°-1°-1,5°-2°...	RAGGIO	1XD-2XD-3XD SHARP	1XD-2XD-3XD Ø1/40	HELPFUL T+S	50/75 100/125	ELIX	FLUTES
	Ø 1	Ø 2	TAPER - (<°)	R	T	S	U	L	E 0°	Z
Ø12 - Ø12 - R0,50/1/2 - 24 - 50/75/100 - (T1-S1) - <0° - Z 5	12	12	0	0,50/1/2	1	1	24	50/75/100	35	5
Ø12 - Ø12 - R0,50/1/2 - 36 - 75/100 - (T1-S2) - <0° - Z 5	12	12	0	0,5/1/2	1	2	36	75/100	35	5
Ø12 - Ø12 - R0,50/1/2 - 48 - 75/100 - (T1-S3) - <0° - Z 5	12	12	0	0,5/1/2	1	3	48	75/100	35	5
Ø12 - Ø12 - R0,50/1/2 - 60 - 100 - (T1-S4) - <0° - Z 5	12	12	0	0,5/1/2	1	4	60	100	35	5

TUTTI I NOSTRI UTENSILI SONO PERSONALIZZABILI IN OGNI PARAMENTRO

Vai a pagina 36 per scoprire come chiedere i tuoi utensili personalizzati!

DIAMETRO > 16 <

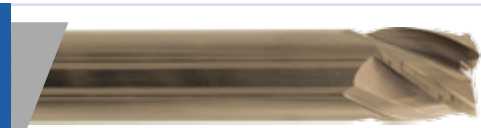

PARAMETRI CONSIGLIATI

S	6000
F	3000/4000
PP	0,15/0,3

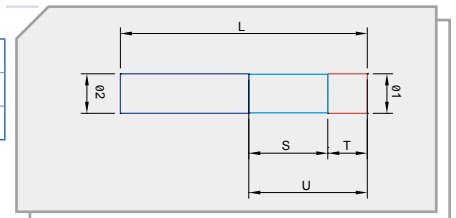

Ø16 CILINDRICHE SCARICATE

CODE: - Ø1-Ø2-R-U-L - (T-S) - <- z	DIAM.1	DIAM.2	0°-0,5°-1°-1,5°-2°...	RAGGIO	1XD-2XD-3XD SHARP	1XD-2XD-3XD Ø1/40	HELPFUL T+S	50/75 100/125	ELIX	FLUTES
	Ø 1	Ø 2	TAPER - (<°)	R	T	S	U	L	E 0°	Z
Ø16 - Ø16 - R0 - 32 - 75/100/125/150 - (T1-S1) - <0° - Z 4	16	16	0	0	1	1	32	75/100/125/150	35°	4
Ø16 - Ø16 - R0 - 48 - 100/125/150 - (T1-S2) - <0° - Z 4	16	16	0	0	1	2	48	100/125/150	35	4
Ø16 - Ø16 - R0 - 64 - 100/125/150 - (T1-S3) - <0° - Z 4	16	16	0	0	1	3	64	100/125/150	35	4
Ø16 - Ø16 - R0 - 80 - 125/150 - (T1-S4) - <0° - Z 4	16	16	0	0	1	4	80	125/150	35	4
Ø16 - Ø16 - R0 - 48 - 100/125/150 - (T2-S1) - <0° - Z 4	16	16	0	0	2	1	48	100/125/150	35	4
Ø16 - Ø16 - R0 - 64 - 100/125/150 - (T2-S2) - <0° - Z 4	16	16	0	0	2	2	64	100/125/150	35	4
Ø16 - Ø16 - R0 - 80 - 125/150 - (T3-S2) - <0° - Z 4	16	16	0	0	3	2	80	125/150	35	4

TUTTI I NOSTRI UTENSILI SONO PERSONALIZZABILI IN OGNI PARAMENTRO

Vai a pagina 36 per scoprire come chiedere i tuoi utensili personalizzati!



Ø16 TORICHE STANDARD

PARAMETRI CONSIGLIATI

S	6000
F	3000/5000
PP	0,15/0,3

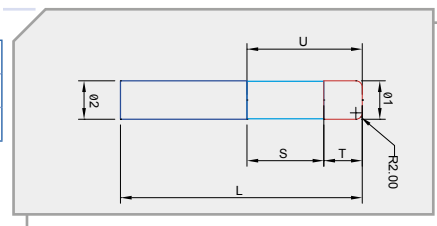

CODE: - Ø1-Ø2-R-U-L - (T-S) - < - Z	DIAM.1	DIAM.2	0°-0,5°-1°-1,5°-2°...	RAGGIO	1XD-2XD-3XD SHARP	1XD-2XD-3XD Ø1/40	HELPFUL T+S	50/75 100/125	ELIX	FLUTES
	Ø 1	Ø 2	TAPER - (<°)	R	T	S	U	L	E 0°	Z
Ø16 - Ø16 - R0,50/1/2 - 32 - 75/100/125/150 - (T1-S1) - <0° - Z 4	16	16	0	0,50/1/2	1	1	32	75/100/125/150	35	4
Ø16 - Ø16 - R0,50/1/2 - 48 - 100/125/150 - (T1-S2) - <0° - Z 4	16	16	0	0,5/1/2	1	2	48	100/125/150	35	4
Ø16 - Ø16 - R0,50/1/2 - 64 - 100/125/150 - (T1-S3) - <0° - Z 4	16	16	0	0,5/1/2	1	3	64	100/125/150	35	4
Ø16 - Ø16 - R0,50/1/2 - 80 - 125/150 - (T1-S4) - <0° - Z 4	16	16	0	0,5/1/2	1	4	80	125/150	35	4

TUTTI I NOSTRI UTENSILI SONO PERSONALIZZABILI IN OGNI PARAMENTRO

Vai a pagina 36 per scoprire come chiedere i tuoi utensili personalizzati!



Ø16 CILINDRICHE STANDARD

PARAMETRI CONSIGLIATI

S	6000
F	3000/4000
PP	0,15/0,3

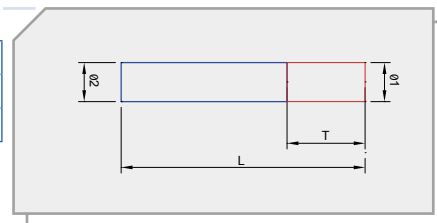

CODE: - Ø1-Ø2-R-U-L - (T-S) - < - Z	DIAM.1	DIAM.2	0°-0,5°-1°-1,5°-2°...	RAGGIO	1XD-2XD-3XD SHARP	1XD-2XD-3XD Ø1/40	HELPFUL T+S	50/75 100/125	ELIX	FLUTES
	Ø 1	Ø 2	TAPER - (<°)	R	T	S	U	L	E 0°	Z
Ø16 - Ø16 - R0 - 16 - 75/100/125/150 - (T1-S0) - <0° - Z 4	16	16	0	0	1	0	16	75/100/125/150	35	4
Ø16 - Ø16 - R0 - 32 - 75/100/125/150 - (T2-S0) - <0° - Z 4	16	16	0	0	2	0	32	75/100/125/150	35	4
Ø16 - Ø16 - R0 - 48 - 100/125/150 - (T3-S0) - <0° - Z 4	16	16	0	0	3	0	48	100/125/150	35	4

TUTTI I NOSTRI UTENSILI SONO PERSONALIZZABILI IN OGNI PARAMENTRO

Vai a pagina 36 per scoprire come chiedere i tuoi utensili personalizzati!



Ø16 TORICHE 5 TAGLIENTI

PARAMETRI CONSIGLIATI

S	6000
F	3000/5000
PP	0,15/0,3

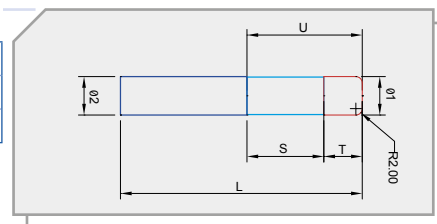

CODE: - Ø1-Ø2-R-U-L - (T-S) - < - Z	DIAM.1	DIAM.2	0°-0,5°-1°-1,5°-2°...	RAGGIO	1XD-2XD-3XD SHARP	1XD-2XD-3XD Ø1/40	HELPFUL T+S	50/75 100/125	ELIX	FLUTES
	Ø 1	Ø 2	TAPER - (<°)	R	T	S	U	L	E 0°	Z
Ø16 - Ø16 - R0,50/1/2 - 32 - /75/100/125/150 - (T1-S1) - <0° - Z 5	16	16	0	0,50/1/2	1	1	32	/75/100/125/150	35	5
Ø16 - Ø16 - R0,50/1/2 - 48 - 75/100/125/150 - (T1-S2) - <0° - Z 5	16	16	0	0,5/1/2	1	2	48	75/100/125/150	35	5
Ø16 - Ø16 - R0,50/1/2 - 64-100/125/150 - (T1-S3) - <0° - Z 5	16	16	0	0,5/1/2	1	3	64	100/125/150	35	5
Ø16 - Ø16 - R0,50/1/2 - 80-100/125/150 - (T1-S4) - <0° - Z 5	16	16	0	0,5/1/2	1	4	80	100/125/150	35	5

TUTTI I NOSTRI UTENSILI SONO PERSONALIZZABILI IN OGNI PARAMENTRO

Vai a pagina 36 per scoprire come chiedere i tuoi utensili personalizzati!



DIVISIONE UTENSILI
SETTORE | STAMPI

Personalizza i tuoi utensili.

Tutti gli utensili della linea GM sono totalmente personalizzabili. Le loro specifiche possono essere modificate a seconda delle richieste del cliente per adattarsi meglio a ogni tipologia di lavoro da svolgere.

Contattaci via telefono o mail verrete richiamati direttamente dal nostro commerciale.

Come fare l'ordine



Contattaci via telefono o mail. Verrai ricontattato dal nostro commerciale che spiegherà nei dettagli come inviare e compilare il file degli utensili personalizzati.



REGISTRAZIONE
CLIENTE



COMPILARE FILE
CON VALORI
PERSONALIZZATI



ELABORAZIONE
ORDINE

Compila il file excel, il codice dell'utensile comparirà in automatico. Una volta finito basterà salvare il file e inoltrarlo alla nostra mail.

2	CODE:	Ø1-Ø2-R-Ø3 (T-S) < Z	Ø4-Ø5-T-L-S-F...	10-D0-S0...	S = 10-D0-S0... Ø1/40	T=8	S0/S100125...	BLK	FLUTES: 2	HRC	N° PIECES	PRICE Euro	TOTAL PRICE
3		DIAMETER Ø1/2	DIAMETER Ø3	TAPER L<T>	RADIUS R	SHARP T	DOWNLOADED Ø40 (S)	HELPPUL (S)	TOTAL LENGTH (L)	Ø1"			
4	Ø-Ø	R-Ø	(T-S)	<	Z			0					0
5	Ø-Ø	R-Ø	(T-S)	<	Z			0					0
6	Ø-Ø	R-Ø	(T-S)	<	Z			0					0
7	Ø-Ø	R-Ø	(T-S)	<	Z			0					0
8	Ø-Ø	R-Ø	(T-S)	<	Z			0					0
9	Ø-Ø	R-Ø	(T-S)	<	Z			0					0
10	Ø-Ø	R-Ø	(T-S)	<	Z			0					0
11	Ø-Ø	R-Ø	(T-S)	<	Z			0					0

Contatti



Tel. +39 035 4829554
Fax +39 035 48 29 667



e-Mail: divisioneutensili@gmmaffei.it



Note tecniche/



A series of horizontal dotted lines providing space for technical notes.

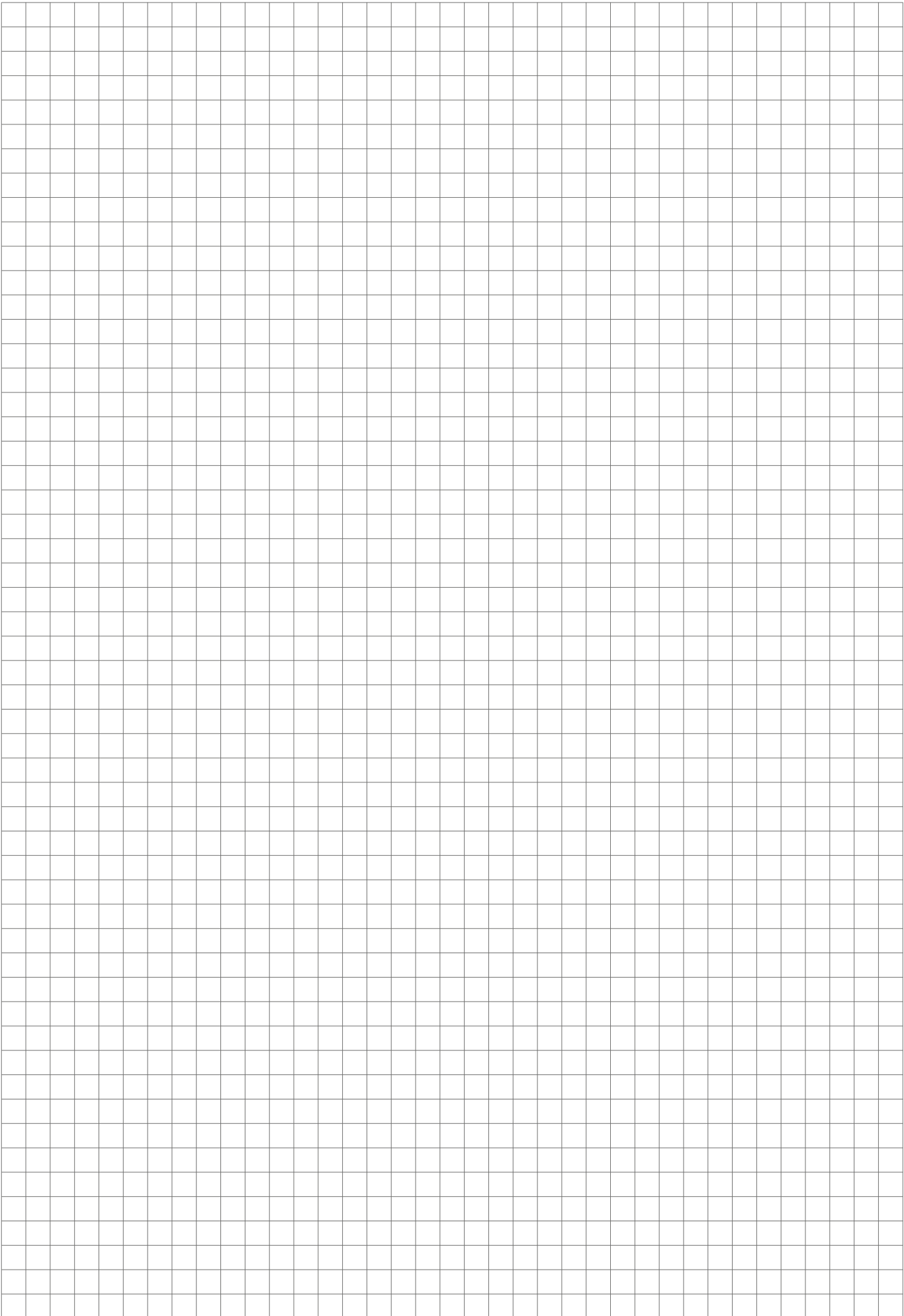



OFFICINA MECCANICA

G.M. s.a.s.
dei **F.LLI MAFFEIS SIMONE E FEDERICO & C.**

COSTRUZIONI STAMPI
PER MATERIE PLASTICHE

Via Fantoni, 13
24049 **VERDELLO - BG - ITALY**

Tel. +39 035 4829554
Fax +39 035 48 29 667
e-Mail: divisioneutensili@gmmaffeis.it